

CSE508 Network Security

11/9/2017 **Intrusion Detection**

Michalis Polychronakis

Stony Brook University

Intrusion

“Any set of actions that attempt to compromise the integrity, confidentiality or availability of information resources” [Heady et al.]

“An attack that exploits a vulnerability which results to a compromise of the security policy of the system”
[Lindqvist and Jonsson]

Most intrusions...

- Are carried out remotely

- Exploit software vulnerabilities

- Result in arbitrary code execution or unauthorized data access on the compromised host

Not the only way!

Intrusion Method

Social engineering (phishing, spam, scareware, phone call, ...)

Viruses/malware (~~disks, CD-ROMs~~, USB sticks, downloads, ...)

Network traffic interception (access credentials, keys, tokens, ...)

Password guessing (root:12345678, brute force cracking, ...)

Physical access (reboot, keylogger, screwdriver, ...)

Software vulnerability exploitation

...

Attack Source

Local

Unprivileged access → privilege escalation

Physical access → USB and other I/O ports, BIOS, wiretapping, memory/storage acquisition, bugging input devices, physical damage, ...

Remote

Internet

Local network (Ethernet, WiFi, 3/4/5G, bluetooth, ...)

Infected media (disks, CD-ROMs, USB sticks, ...)

Phone (social engineering)

Less risk, more targets...

Attack Outcome

Arbitrary code execution

Privilege escalation

Disclosure of confidential information

Unauthorized access

DoS

Erroneous output

Destruction

...

Intrusion Detection

Intrusion detection systems monitor networks or hosts for malicious activities or policy violations

Detection (IDS): just generate alerts and log any identified events

Prevention (IPS): in addition, react by blocking the detected activity



Defense in Depth

An IDS is not a silver bullet solution

Just an additional layer of defense

Complements existing protections, detectors, and policy enforcement mechanisms

There will always be new vulnerabilities, new exploitation techniques, and new adversaries

Single defenses may fail

Multiple and diverse defenses make the attacker's job harder

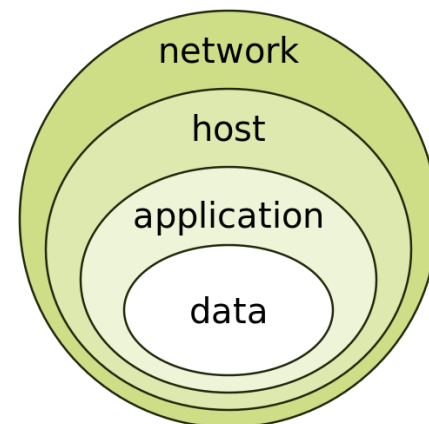

Defense in Depth

Securing systems retroactively is not always easy

WiFi access points, routers, printers, IP phones, mobile phones, legacy devices, TVs, IoT, ...

Detecting and blocking an attack might be easier/faster than understanding and fixing the bug

Immediate response vs. long-term treatment

Patches for 0-day exploits take time to develop and deploy

Focus not only on detecting attacks

But also on their side effects, and unexpected events in general

Example: extrusion detection/data leak prevention → detect data exfiltration

Situational Awareness

Understanding of what is happening on the network and in the IT environment

Confirm security goals

Identify and respond to unanticipated events

Diverse sources of data

Passive/active network/host monitoring, scanning/probing, performance metrics/statistics, server/transaction logs, external (non IT) indicators, ...

Use data analytics to make sense of the increasing amount of data: identify features, derive models, observe patterns, ...

Data mining, machine learning, ...



Basic Concepts: Location

An IDS can be a separate device or a software application

Operates on captured *audit data*

Off-line (e.g., periodic) vs. real-time processing

Network (NIDS)

NetFlow records, raw packets, reassembled streams, ...

Passive (IDS) vs. in-line (IPS) operation

Examples: Snort, Bro, Suricata, many commercial boxes, ...

Host (HIDS)

Login times, resource usage, user actions/commands, process/file/socket activity, application/system log files, registry changes, API calls, system calls, executed instructions, ...

Examples: OSquery, OSSEC, SysDig, El Jefe, AVs, registry/process/etc. monitors, network content scanners, ...

Basic Concepts: Location

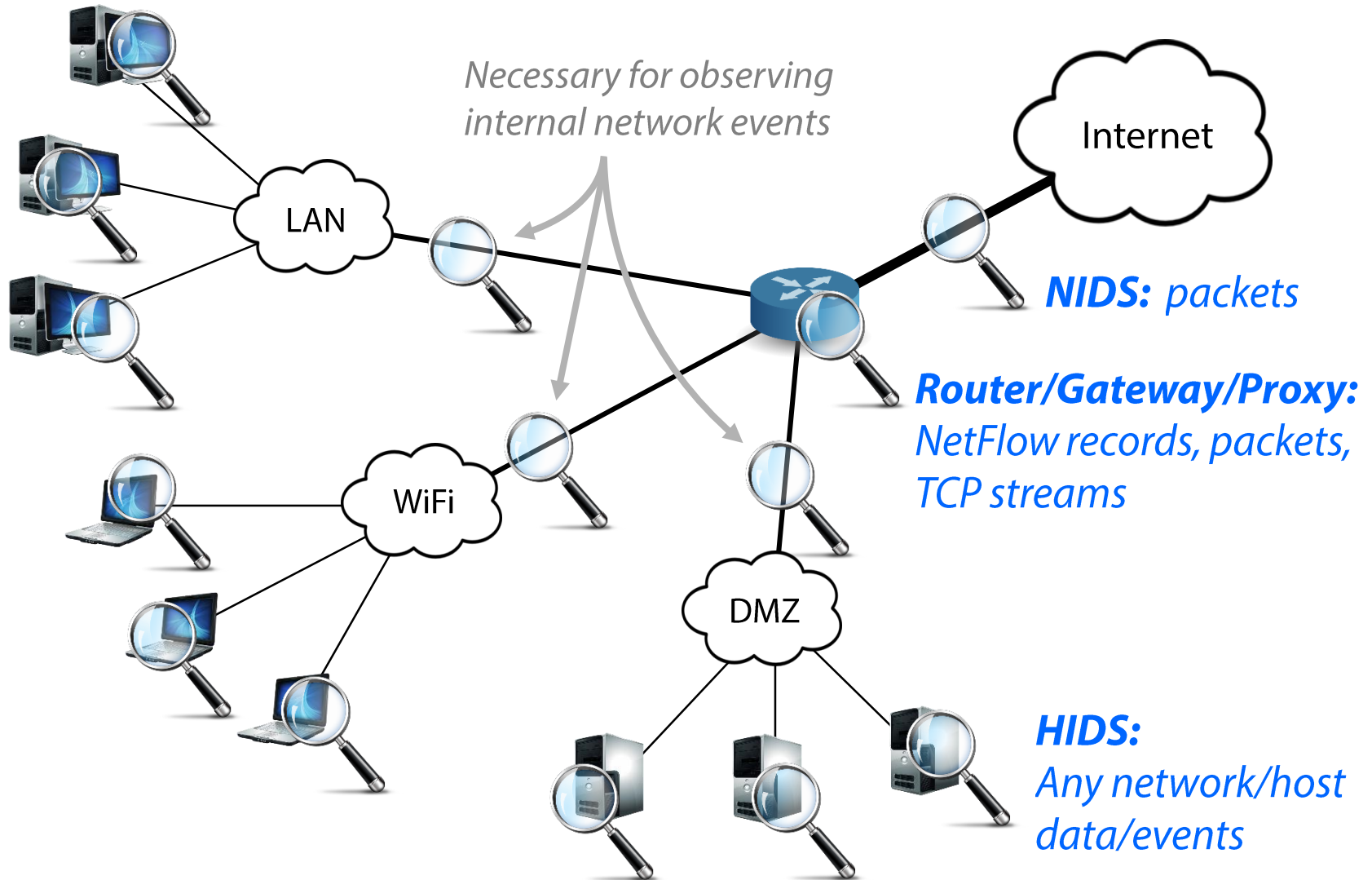

Deployment

NIDS: protect many hosts with a single detector

HIDS: install detector on each host (might not always be feasible)

Visibility

NIDS: can observe broader events and global patterns

HIDS: observes only local events that might not be visible at the network

Context

NIDS: packets, unencrypted streams (unless proxy-level SSL inspection)

HIDS: full picture

Overhead

NIDS: none (passive)

NIPS/Proxy: adds some latency

HIDS: eats up CPU/memory (varies from negligible to complete hogging)

Subversion

NIDS: invisible in the network

NIPS/Proxy: failure may lead to unreachable network

HIDS: attacker may disable it and alter the logs (user vs. kernel level, in-VM vs. out-of-VM, remote audit logs)

Basic Concepts: Detection Method

Misuse detection

Predefined patterns (known as “signatures” or “rules”) of known attacks

Rule set must be kept up to date

Manual vs. automated signature specification (latter is *hard*)

Can detect only *known* attacks, with adequate precision

Anomaly detection

Rely on models of “normal” behavior

Requires (re)training with an adequate amount of data

Can detect previously unknown attacks

Prone to false positives

IDS Challenges

Conflicting goals

- Zero-day attack detection

- Zero false positives

Resilience to evasion

Detection of targeted and stealthy attacks

Adaptability to a constantly evolving environment

- New threats, new topology, new services, new users, ...

- Rule sets must be kept up to date according to new threats

- Models must be updated/retrained (*concept drift*)

Coping with an increasing amount of data

Popular Open-source Signature-based NIDS



Snort



Bro



Suricata

Use Case: Snort

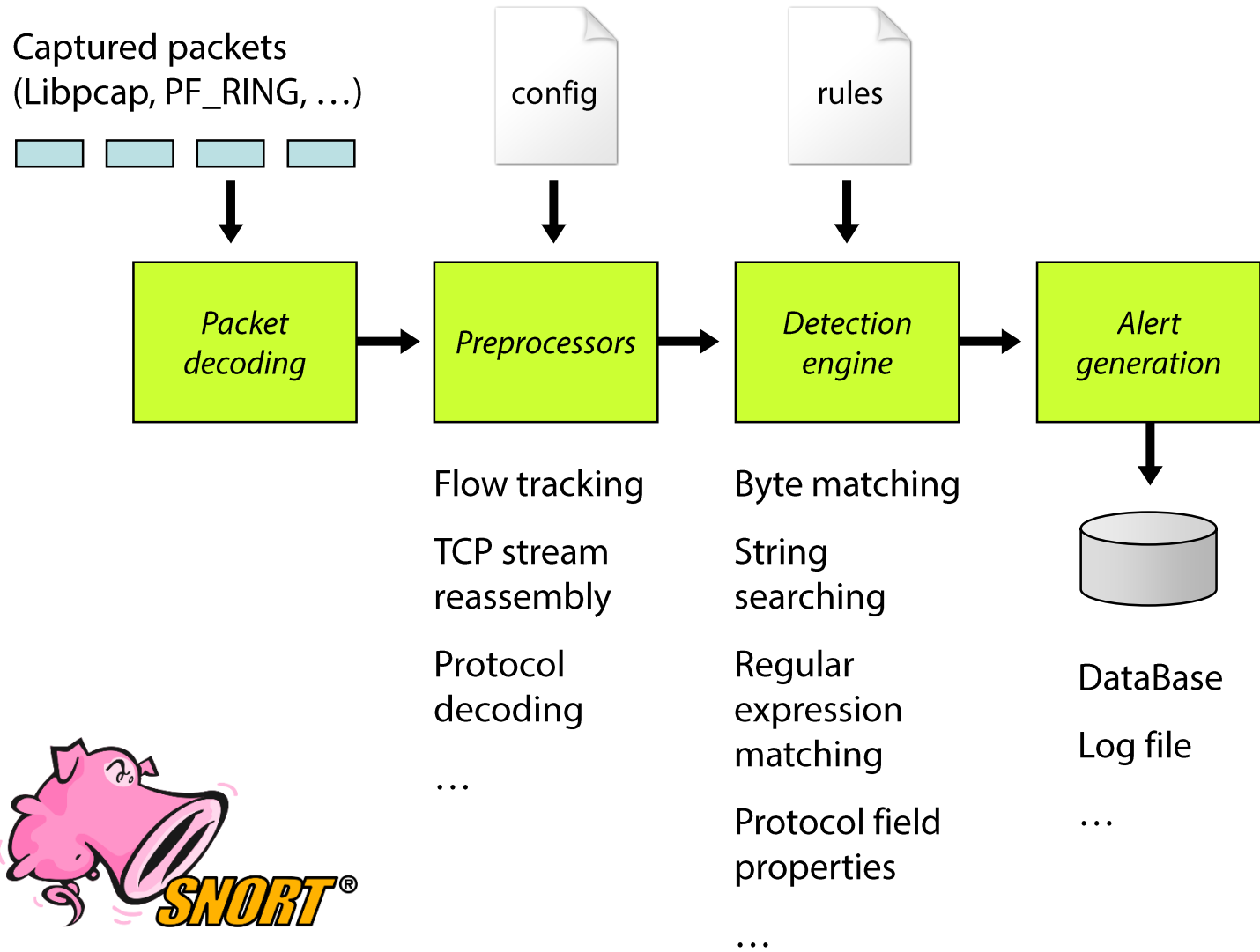

What is a Signature?

An attack description as seen at Layer 2-7

Example Snort signature for Witty worm:

action *protocol* *source/destination* *content*

↓ ↙ ↘ ↓ ↓

alert **udp** **any 4000 -> 193.92.123.0/24 any** (msg:"ISS
PAM/Witty Worm Shellcode"; **content:"|65 74 51 68 73 6f 63 6b
54 53|"**; **depth:246**; sid:1000078; rev:1;)

More Examples

String searching

```
alert ip $EXTERNAL_NET $SHELLCODE_PORTS -> $HOME_NET any  
(msg:"SHELLCODE Linux shellcode"; content:"|90 90 90 E8 C0 FF  
FF FF|/bin/sh"; classtype:shellcode-detect; sid:652; rev:9;)
```

Strsearch + regexp matching + stateful inspection

```
alert tcp $EXTERNAL_NET any -> $HOME_NET 10202:10203 (msg:"CA  
license GCR overflow attempt"; flow:to_server,established;  
content:"GCR NETWORK<"; depth:12; offset:3; nocase;  
pcre:"/^\S{65}|\S+\s+\S{65}|\S+\s+\S+\s+\S{65}/Ri"; sid:3520;)
```

Stateful Inspection

Semantic gap: NIDS processes individual packets, while applications see a contiguous stream (TCP)

Potential for evasion

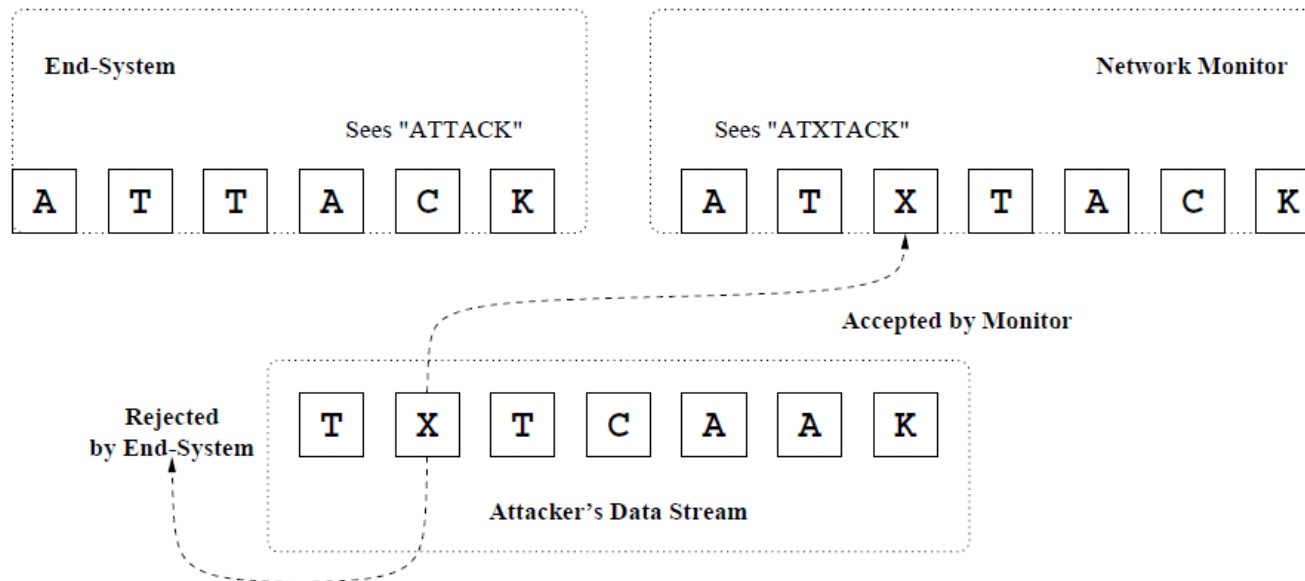

Solution: IP defragmentation, TCP stream reassembly

Flow-level tracking: group packets into flows, track TCP state

Stream reassembly: normalize and merge packets into streams

Different TCP stacks may treat corner cases differently...

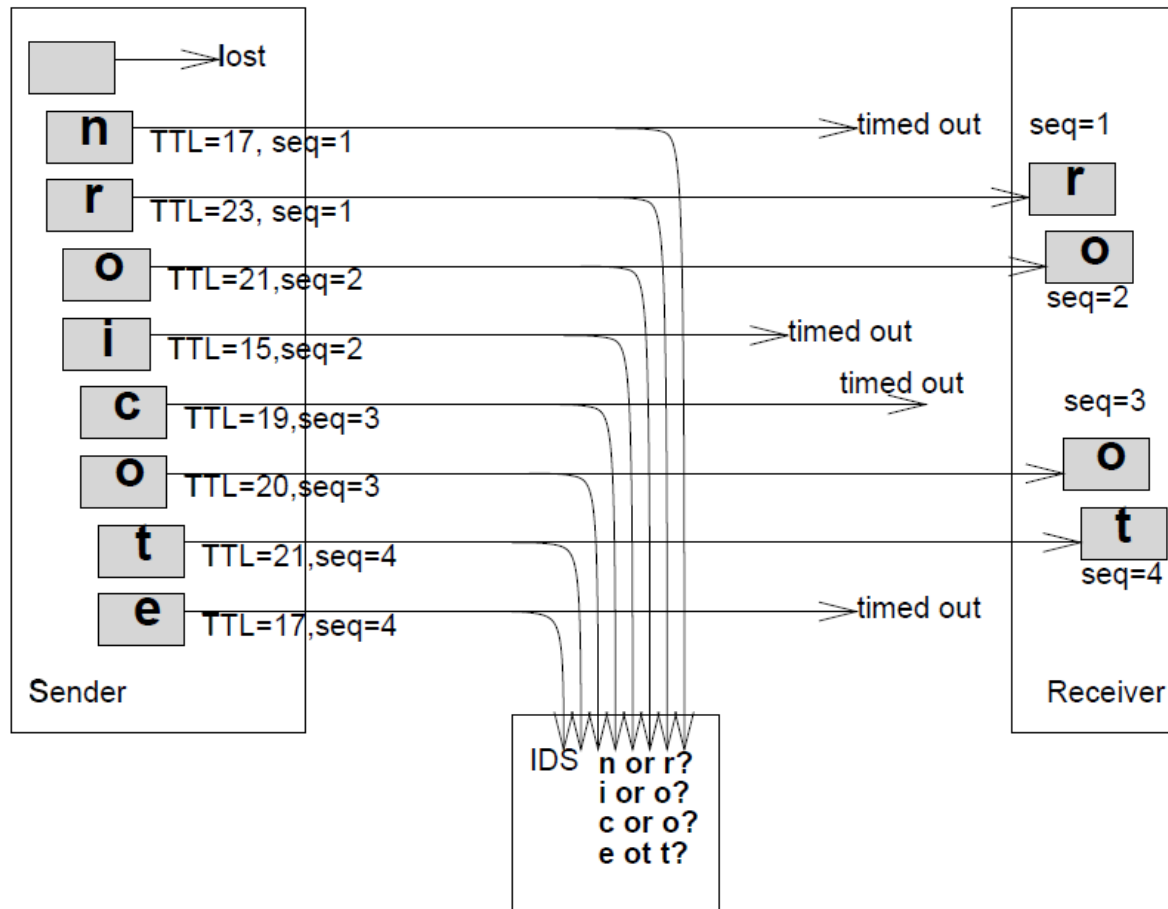

Anomaly Detection

Training phase: build models of normal behavior

Detection phase: alert on deviations from the model

Many approaches

Statistical methods, rule-based expert systems, clustering, state series modeling, artificial neural networks, support vector machines, outlier detection schemes, ...

Good for noisy attacks

Port scanning, failed login attempts, DoS, worms, ...

Good for “stable” environments

E.g., web server vs. user workstation

Anomaly Detection

Learning

Supervised: Labels available for both benign data and attacks

Semi-supervised: Labels available only for benign data

Unsupervised : No labels: assume that anomalies are very rare compared to benign events

Many possible features

Packet fields, payload content, connection properties, traffic flows, network metrics, system call sequences, code fragments, file attributes, statistics, ...

Evaluating Intrusion Detection Systems

Accuracy is not a sufficient metric!

Example: data set with 99.9% benign and 0.1% malicious events

Dummy detector that marks everything as benign has 99.9% accuracy...

False positive: legitimate behavior was deemed malicious

False negative: an actual attack was not detected

		Detection Result	
		Positive (alert)	Negative (silence)
Actual Event	Positive (malicious)	TP	FN
	Negative (benign)	FP	TN

$$\text{Precision} = \text{TP} / (\text{TP} + \text{FP})$$

$$\text{Recall} = \text{TP} / (\text{TP} + \text{FN})$$

(sensitivity)

$$\text{FP rate} = \text{FP} / (\text{FP} + \text{TN})$$

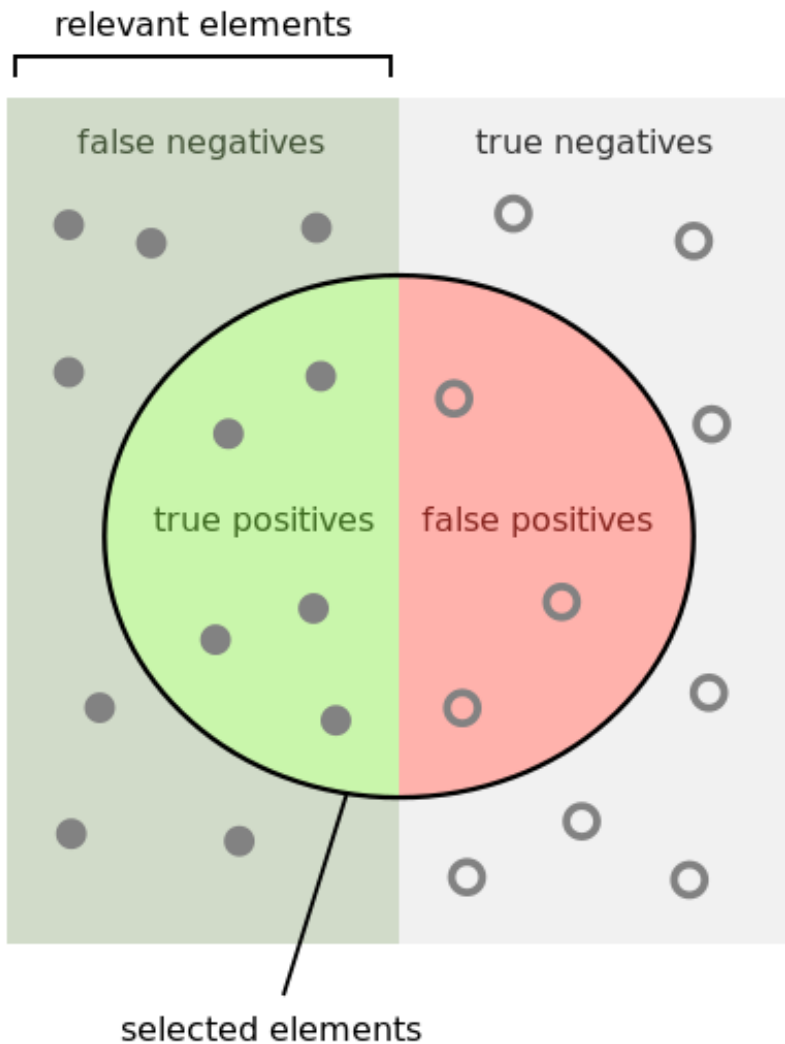

How many selected items are relevant?

$$\text{Precision} = \frac{\text{true positives}}{\text{true positives} + \text{false positives}}$$

How many relevant items are selected?

$$\text{Recall} = \frac{\text{true positives}}{\text{true positives} + \text{false negatives}}$$

Receiver Operating Characteristic (ROC) Curve

Concise representation of a detector's accuracy

Y axis: success rate of detecting signal events

X axis: error rate of falsely identifying noise events

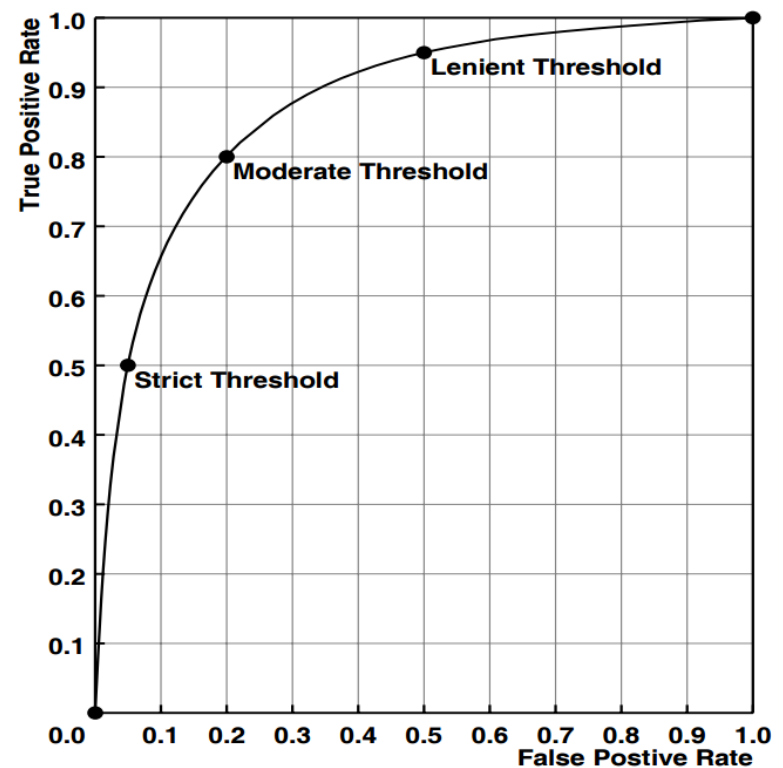
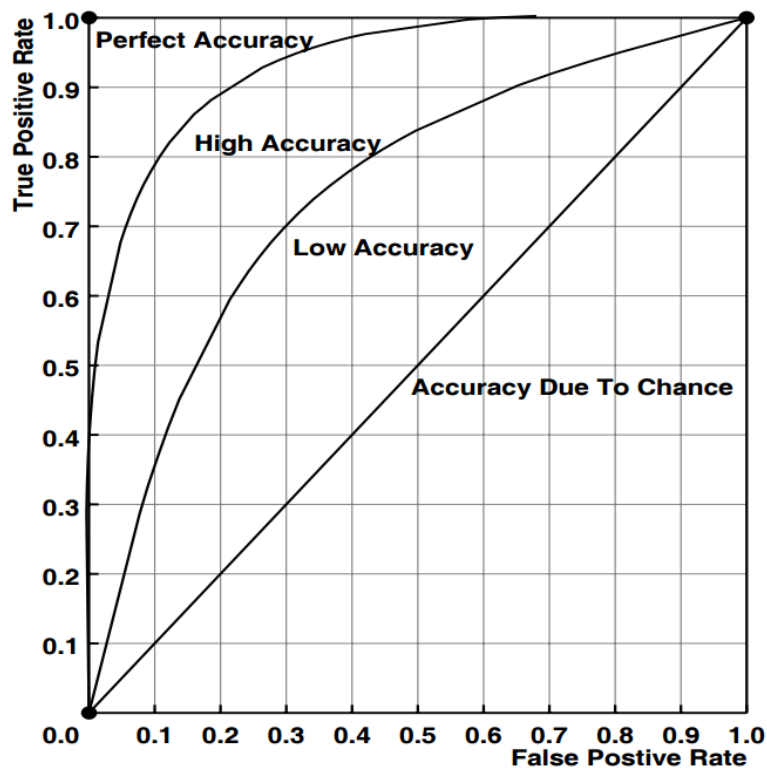

Evasion – *“Stay under the radar”*

Both anomaly and misuse detection systems can be evaded by breaking the detector’s assumptions

- Detectors rely on certain features

- Make those features look legitimate or at least non-suspicious

Many techniques

- Fragmentation

- Content mutation/polymorphism/metamorphism

- Mimicry

- Rate adjustment (slow and stealthy vs. fast and noisy)

- Distribution and coordination (e.g., DoS vs. DDoS)

- Spoofing and stepping stones

- ...