

CSE 548: Analysis of Algorithms

Lecture 13 (Analyzing Parallel Algorithms)

Rezaul A. Chowdhury

Department of Computer Science

SUNY Stony Brook

Fall 2015

Why Parallelism?

Moore's Law

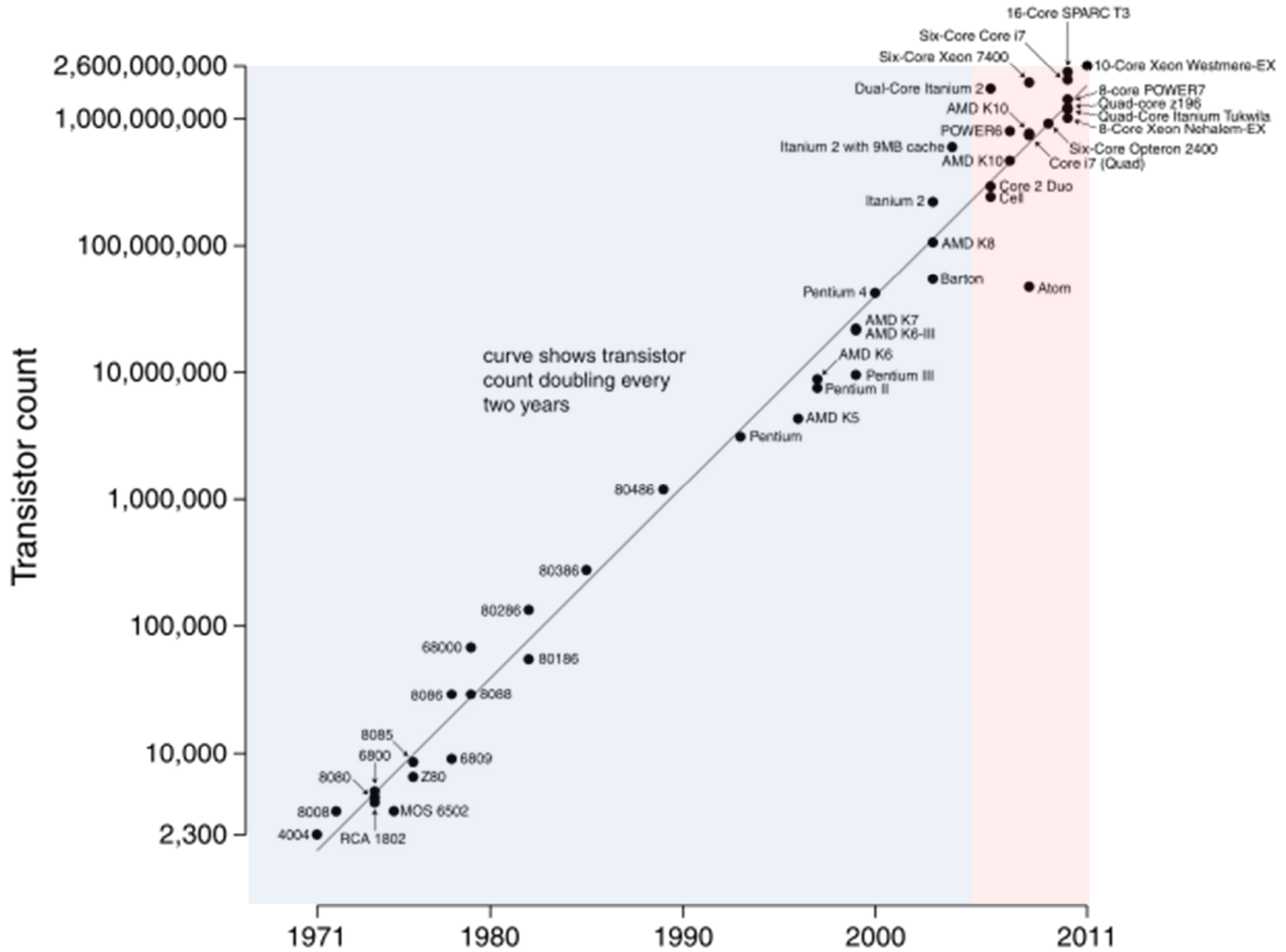

Unicore Performance

Single-Threaded Floating-Point Performance

Based on adjusted SPECfp® results

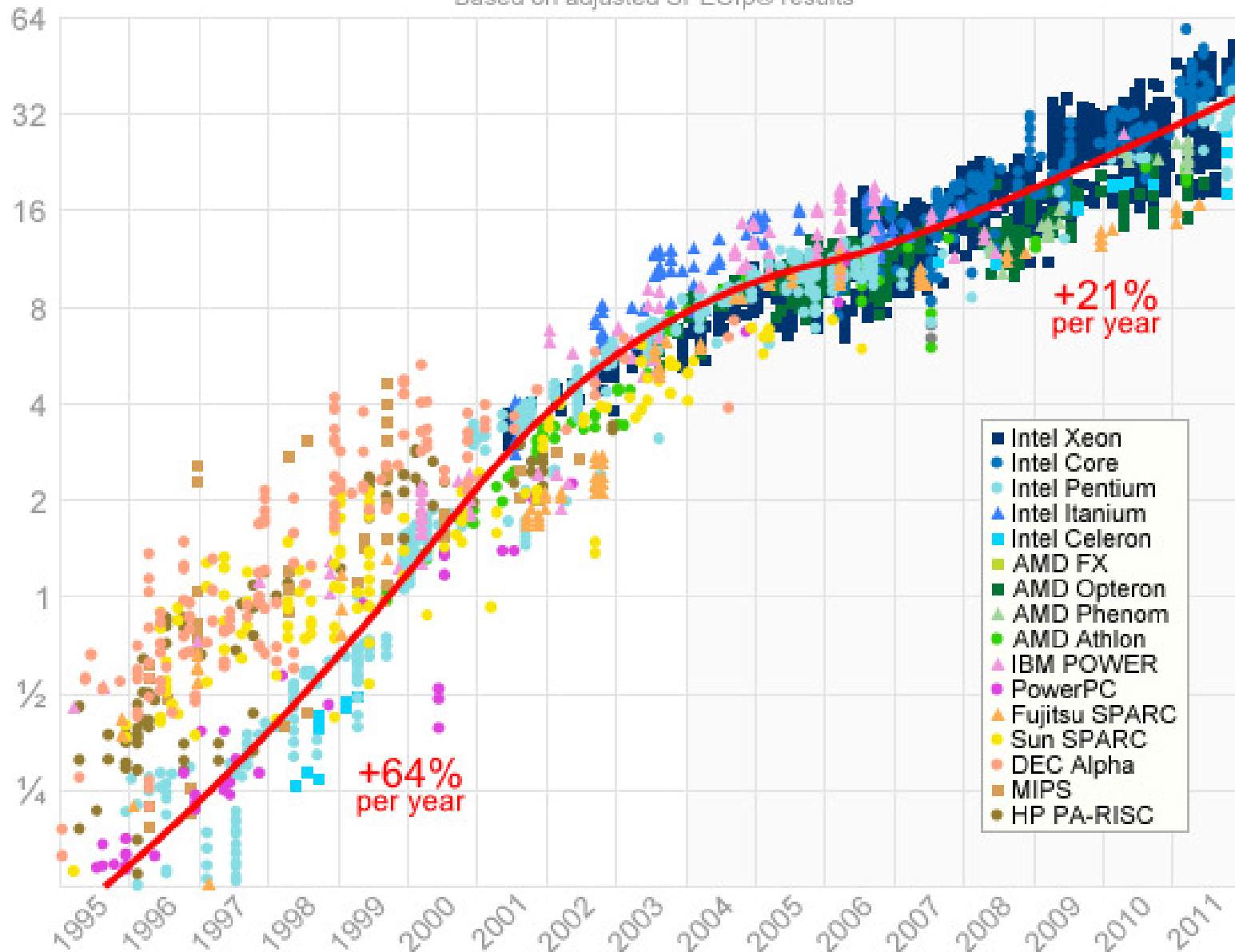

Unicore Performance Has Hit a Wall!

Some Reasons

- Lack of additional ILP
(Instruction Level Hidden Parallelism)
- High power density
- Manufacturing issues
- Physical limits
- Memory speed

Unicore Performance: No Additional ILP

“Everything that can be invented has been invented.”

— Charles H. Duell

Commissioner, U.S. patent office, 1899

Exhausted all ideas to exploit hidden parallelism?

- Multiple simultaneous instructions
- Instruction Pipelining
- Out-of-order instructions
- Speculative execution
- Branch prediction
- Register renaming, etc.

Unicore Performance: High Power Density

- Dynamic power, $P_d \propto V^2 f C$
 - $V = \text{supply voltage}$
 - $f = \text{clock frequency}$
 - $C = \text{capacitance}$
- But $V \propto f$
- Thus $P_d \propto f^3$

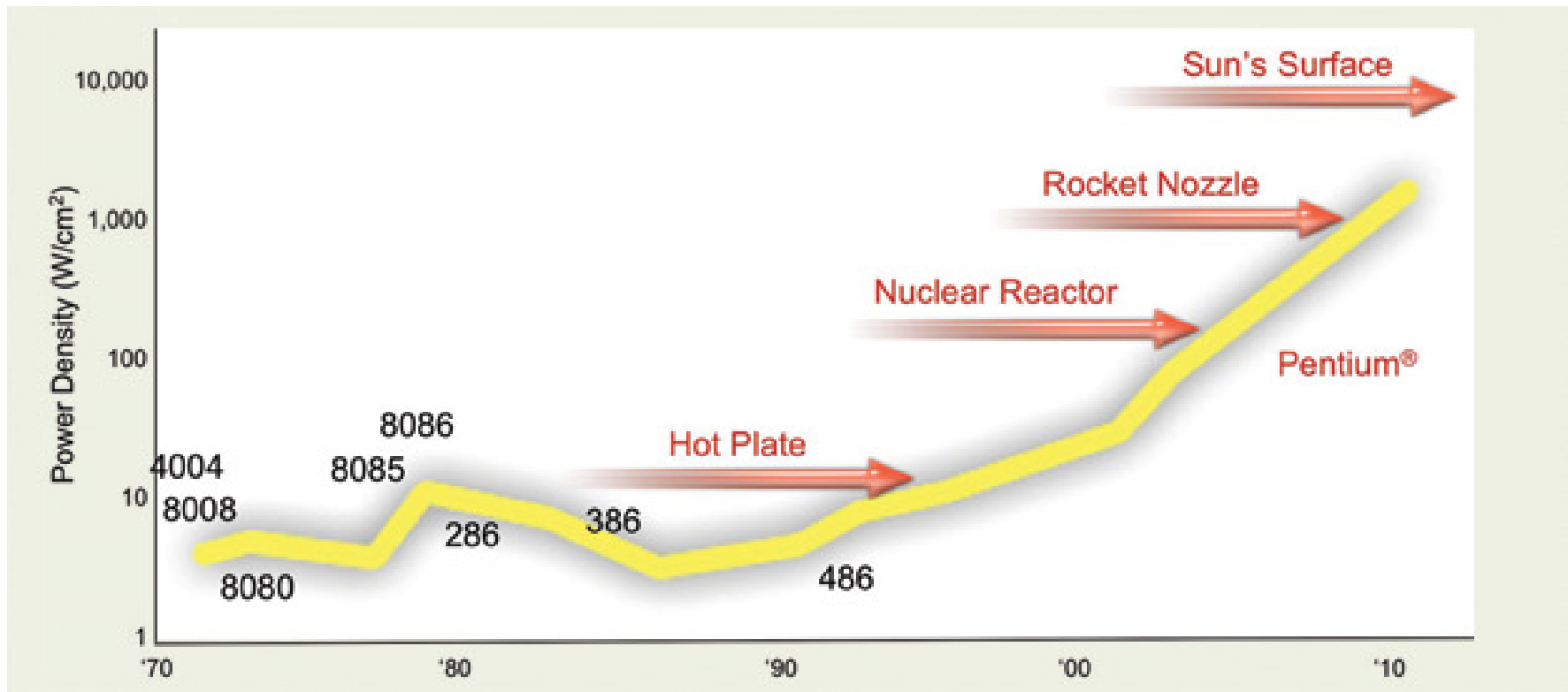

Source: Patrick Gelsinger, Intel Developer Forum, Spring 2004 (Simon Floyd)

Unicore Performance: Manufacturing Issues

- Frequency, $f \propto 1 / s$
 - $s = \text{feature size (transistor dimension)}$
- Transistors / unit area $\propto 1 / s^2$
- Typically, die size $\propto 1 / s$
- So, what happens if feature size goes down by a factor of x ?
 - Raw computing power goes up by a factor of x^4 !
 - Typically most programs run faster by a factor of x^3 without any change!

Unicore Performance: Manufacturing Issues

- Manufacturing cost goes up as feature size decreases
 - Cost of a semiconductor fabrication plant doubles every 4 years (Rock's Law)
- CMOS feature size is limited to 5 nm (at least 10 atoms)

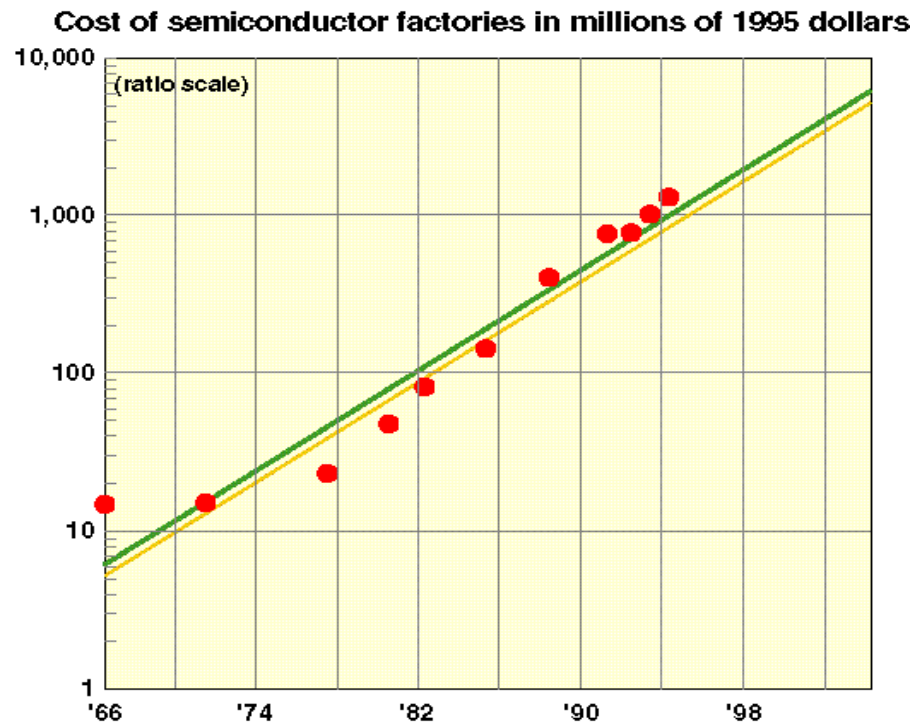

Source: Kathy Yelick and Jim Demmel, UC Berkeley

Unicore Performance: Physical Limits

Execute the following loop on a serial machine in 1 second:

for (i = 0; i < 10¹²; ++i)

z[i] = x[i] + y[i];

- We will have to access 3×10^{12} data items in one second
- Speed of light is, $c \approx 3 \times 10^8$ m/s
- So each data item must be within $c / 3 \times 10^{12} \approx 0.1$ mm from the CPU on the average
- All data must be put inside a 0.2 mm \times 0.2 mm square
- Each data item (≥ 8 bytes) can occupy only 1 \AA^2 space!
(size of a small atom!)

Unicore Performance: Memory Wall

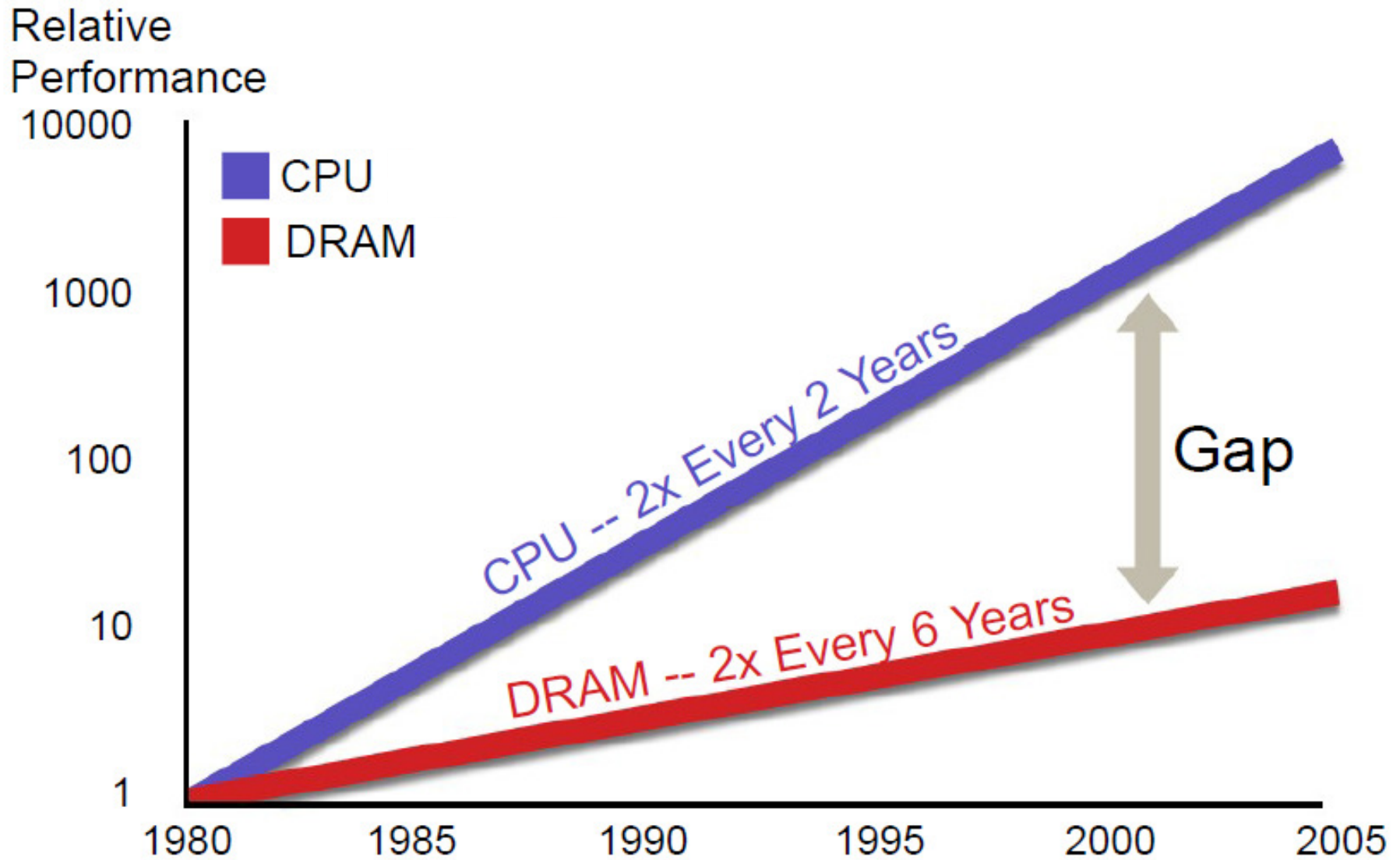

Source: Sun World Wide Analyst Conference Feb. 25, 2003

Source: Rick Hetherington, Chief Technology Officer, Microelectronics, Sun Microsystems

Unicore Performance Has Hit a Wall!

Some Reasons

- Lack of additional ILP
(Instruction Level Hidden Parallelism)
- High power density
- Manufacturing issues
- Physical limits
- Memory speed

“Oh Sinnerman, where you gonna run to?”

— Sinnerman (recorded by Nina Simone)

Where You Gonna Run To?

- Changing f by 20% changes performance by 13%
- So what happens if we overclock by 20%?

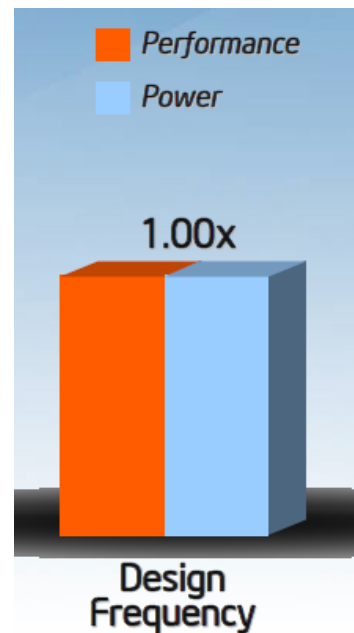

Source: Andrew A. Chien, Vice President of Research, Intel Corporation

Where You Gonna Run To?

- Changing f by 20% changes performance by 13%
- So what happens if we overclock by 20%?
- And underclock by 20%?

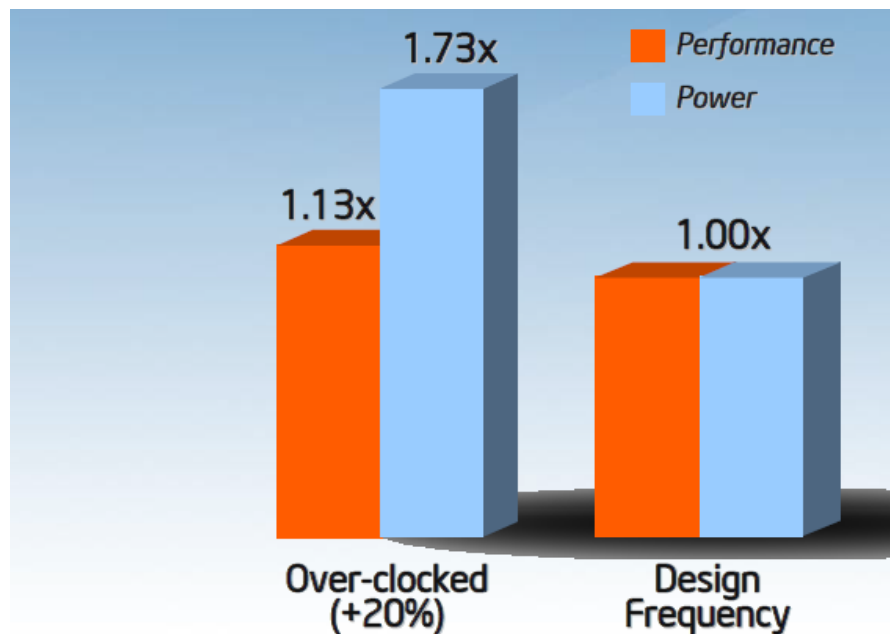

Source: Andrew A. Chien, Vice President of Research, Intel Corporation

Where You Gonna Run To?

- Changing f by 20% changes performance by 13%
- So what happens if we overclock by 20%?
- And underclock by 20%?

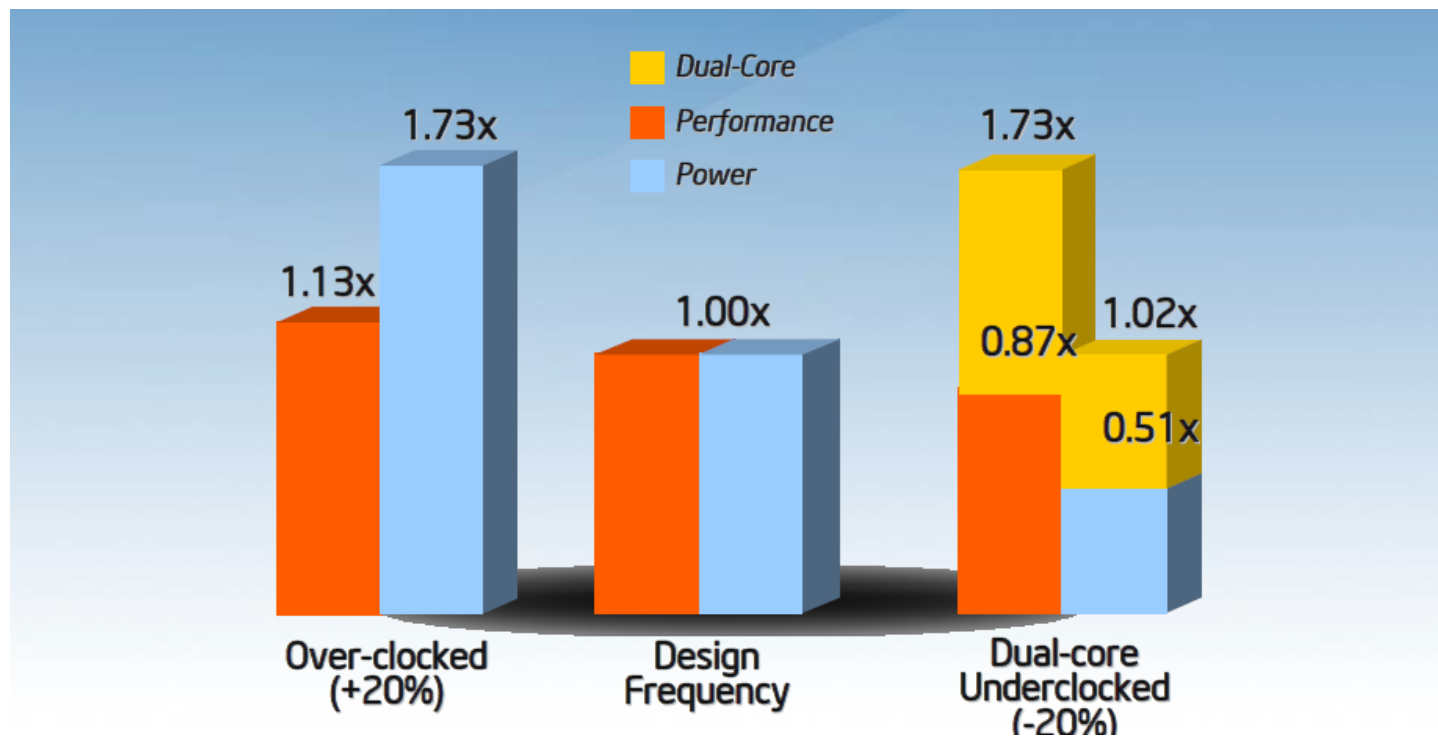

Source: Andrew A. Chien, Vice President of Research, Intel Corporation

Moore's Law Reinterpreted

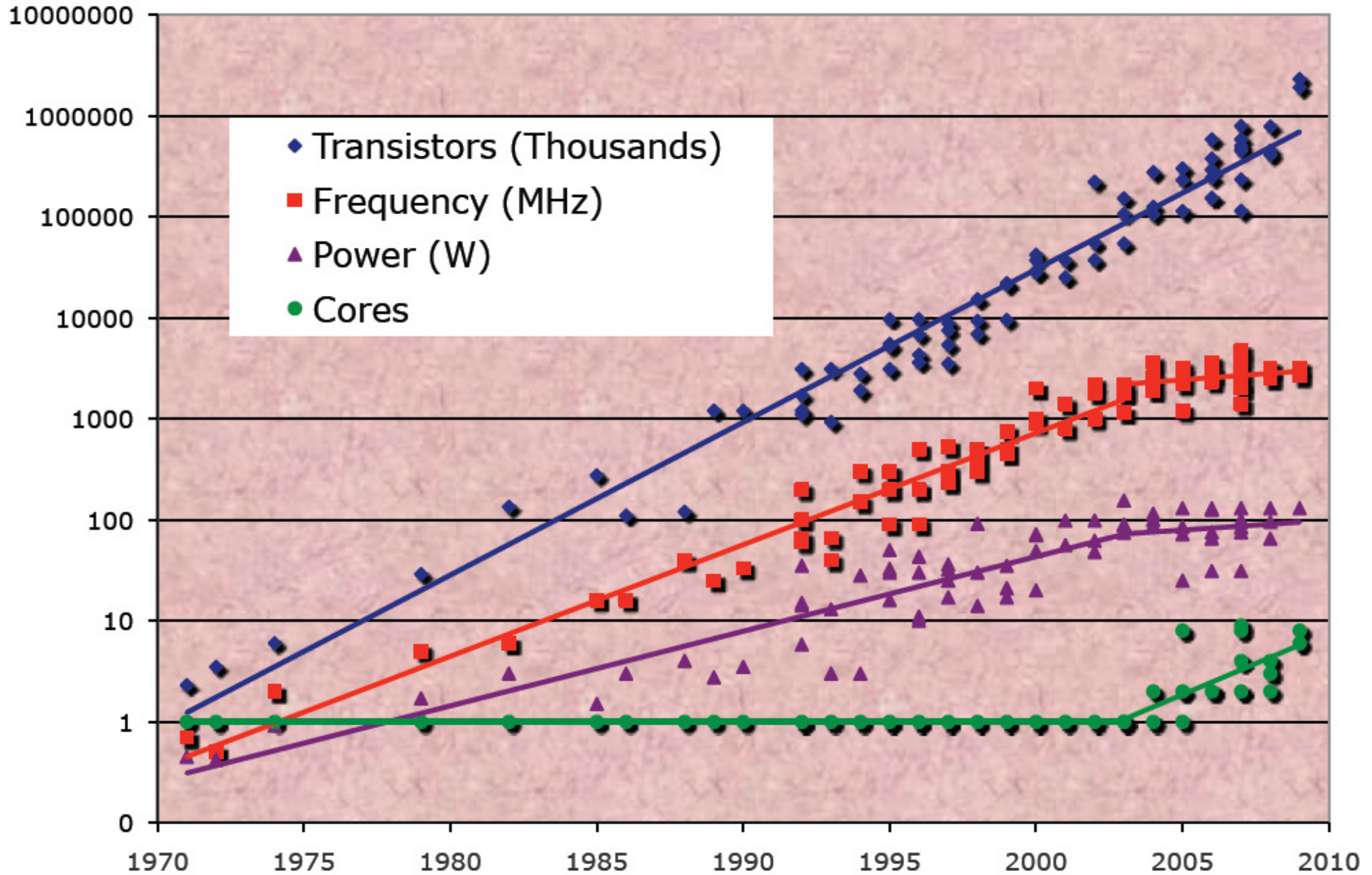

Source: Report of the 2011 Workshop on Exascale Programming Challenges

Top 500 Supercomputing Sites (Cores / Socket)

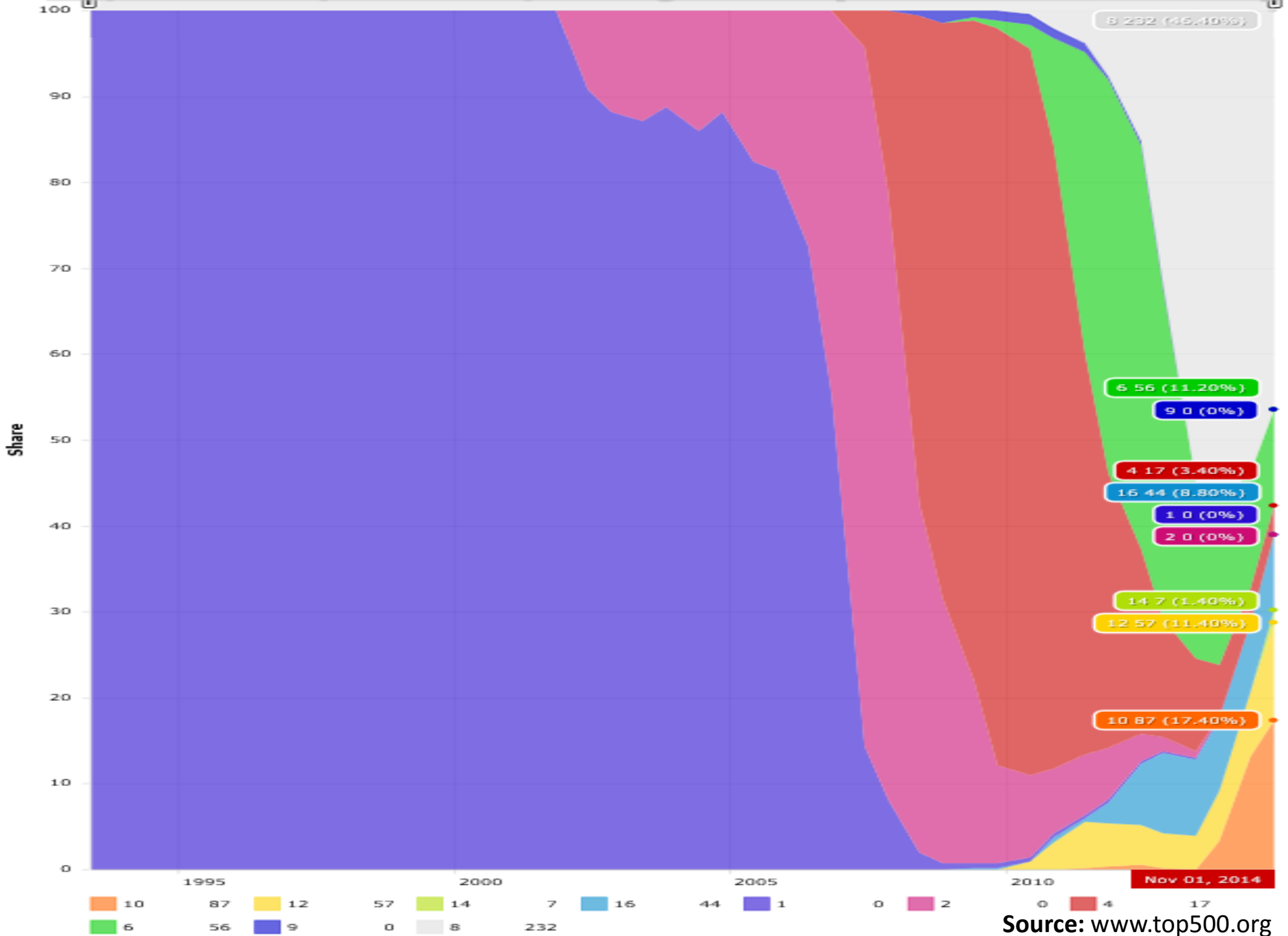

Source: www.top500.org

No Free Lunch for Traditional Software

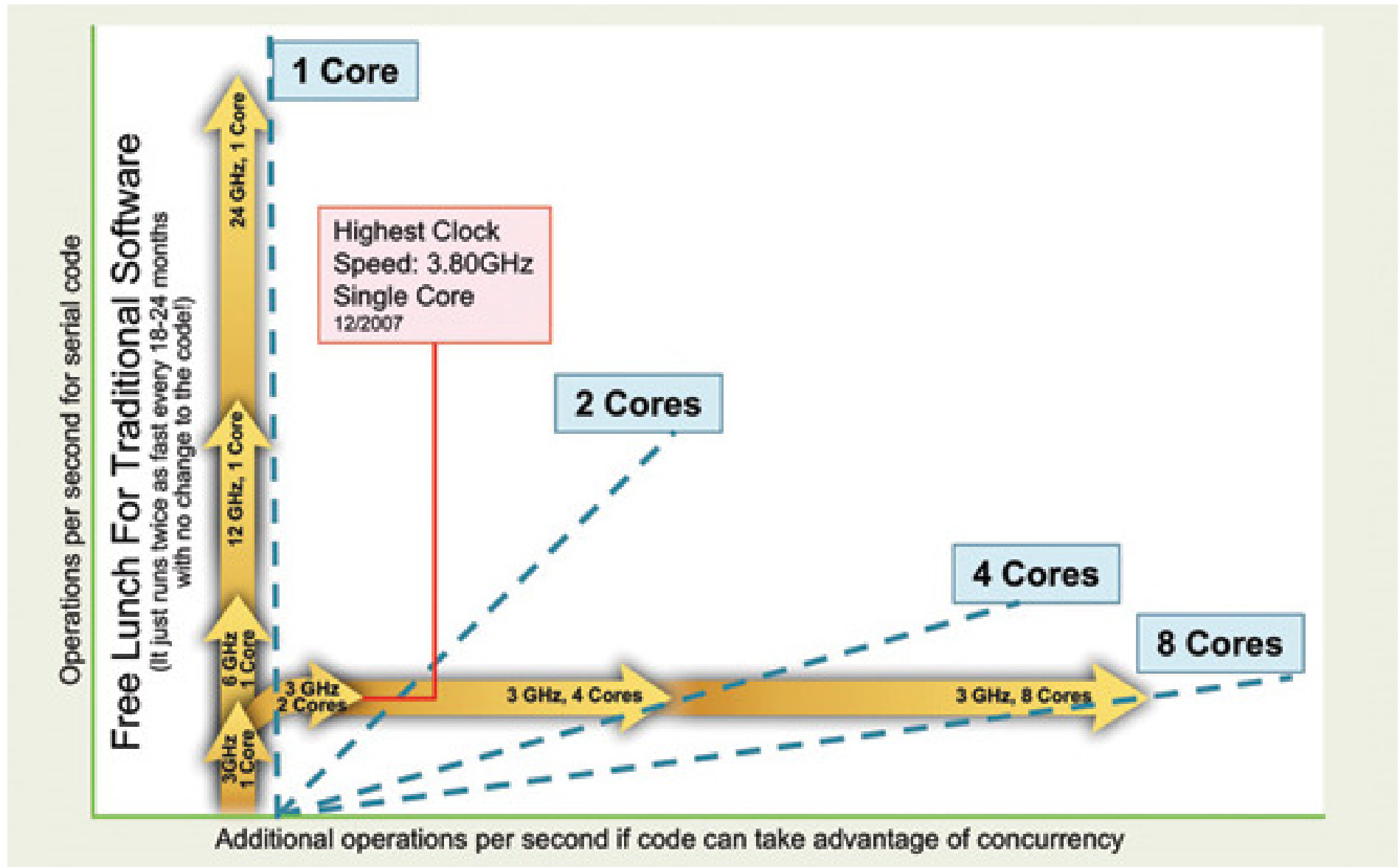

Source: Simon Floyd, Workstation Performance: Tomorrow's Possibilities (Viewpoint Column)

Insatiable Demand for Performance

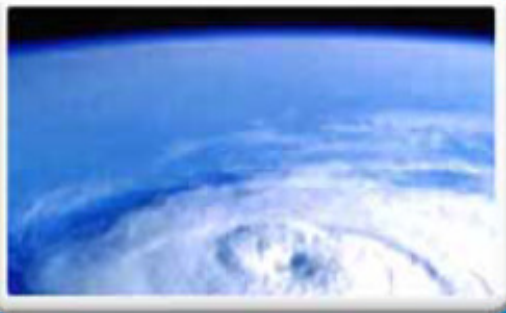

Weather Prediction

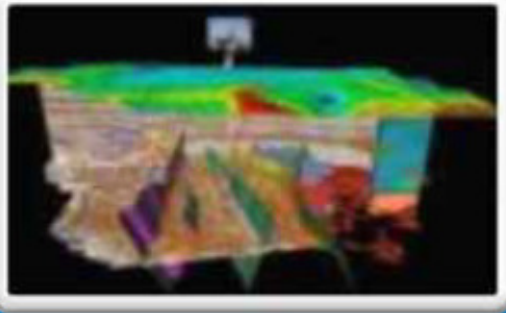

Oil Exploration



Design Simulation



Genomics Research



Financial Analysis

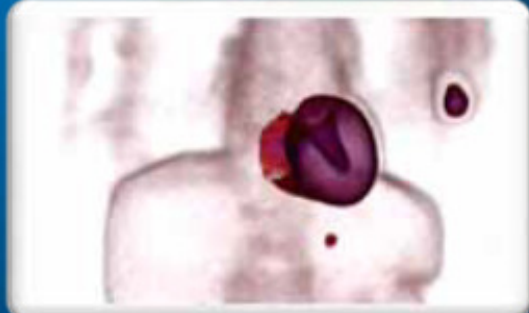

Medical Imaging

Some Useful Classifications of Parallel Computers

Parallel Computer Memory Architecture (Distributed Memory)

- Each processor has its own local memory — no global address space
- Changes in local memory by one processor have no effect on memory of other processors

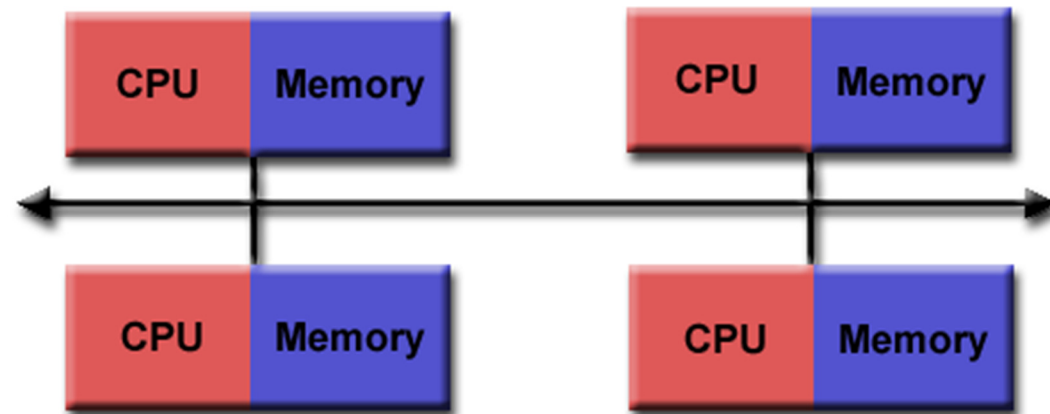

Source: Blaise Barney, LLNL

- Communication network to connect inter-processor memory
- Programming
 - Message Passing Interface (MPI)
 - Many once available: PVM, Chameleon, MPL, NX, etc.

Parallel Computer Memory Architecture (Shared Memory)

- All processors access all memory as global address space
- Changes in memory by one processor are visible to all others
- Two types
 - Uniform Memory Access (UMA)
 - Non-Uniform Memory Access (NUMA)
- Programming
 - Open Multi-Processing (OpenMP)
 - Cilk/Cilk++ and Intel Cilk Plus
 - Intel Thread Building Block (TBB), etc.

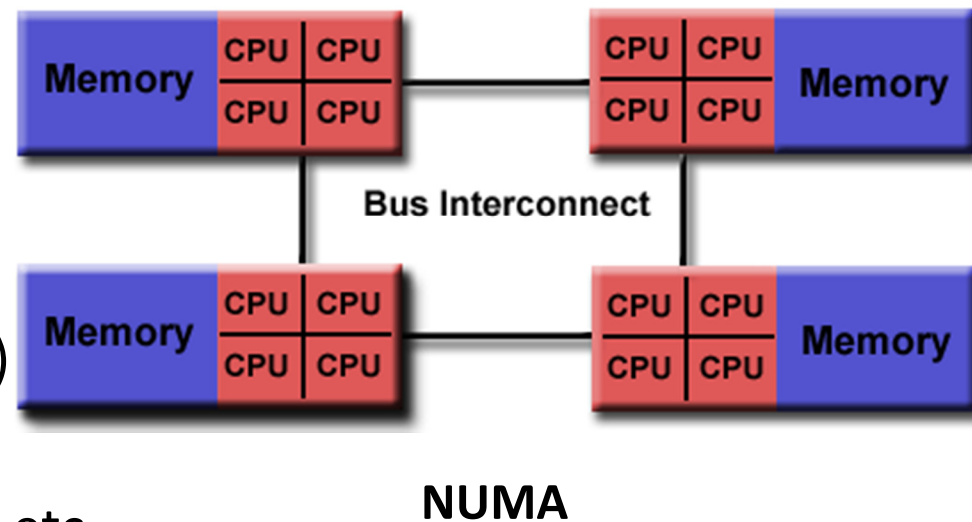
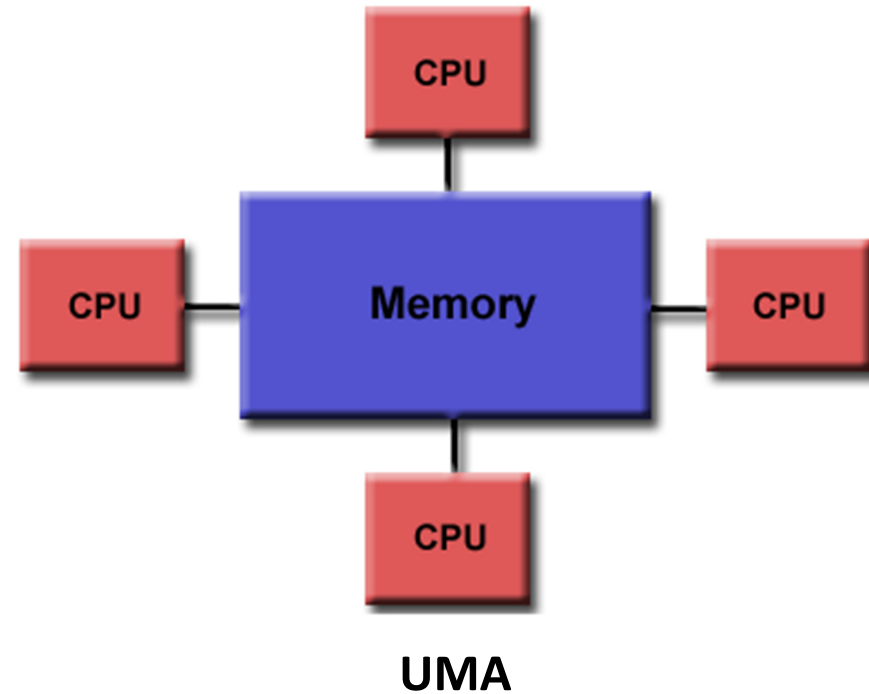

Parallel Computer Memory Architecture (Hybrid Distributed-Shared Memory)

- The share-memory component can be a cache-coherent SMP or a Graphics Processing Unit (GPU)
- The distributed-memory component is the networking of multiple SMP/GPU machines
- Most common architecture for the largest and fastest computers in the world today
- Programming
 - OpenMP / Cilk + CUDA / OpenCL + MPI, etc.

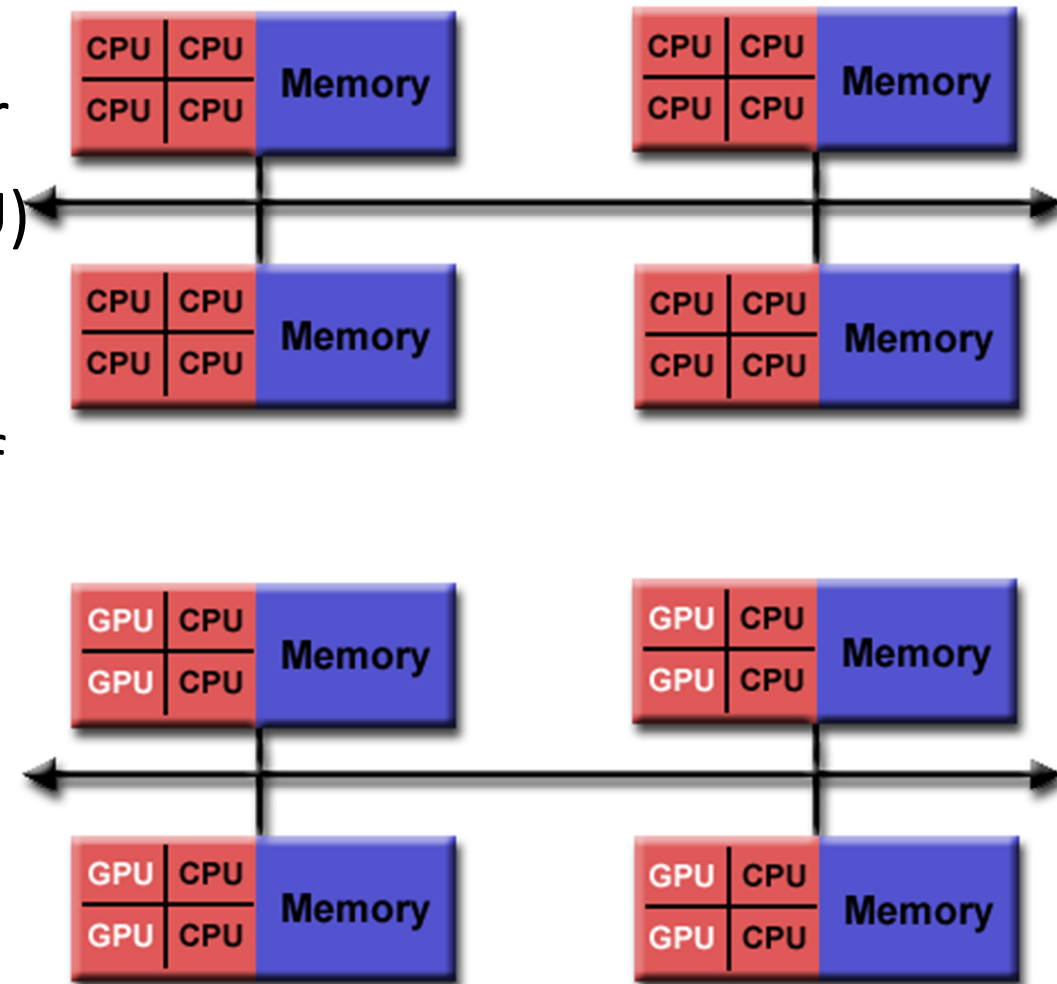

Types of Parallelism

Nested Parallelism

$${}^n C_r = {}^{n-1} C_{r-1} + {}^{n-1} C_r$$

```
int comb ( int n, int r )
{
    if ( r > n ) return 0;
    if ( r == 0 || r == n ) return 1;

    int x, y;

    x = comb( n - 1, r - 1 );
    y = comb( n - 1, r );

    return ( x + y );
}
```

Serial Code

Control cannot pass this point until all spawned children have returned.

Grant permission to execute the called (spawned) function in parallel with the caller.

```
int comb ( int n, int r )
{
    if ( r > n ) return 0;
    if ( r == 0 || r == n ) return 1;

    int x, y;

    x = spawn comb( n - 1, r - 1 );
    y = comb( n - 1, r );

    sync;

    return ( x + y );
}
```

Parallel Code

Loop Parallelism

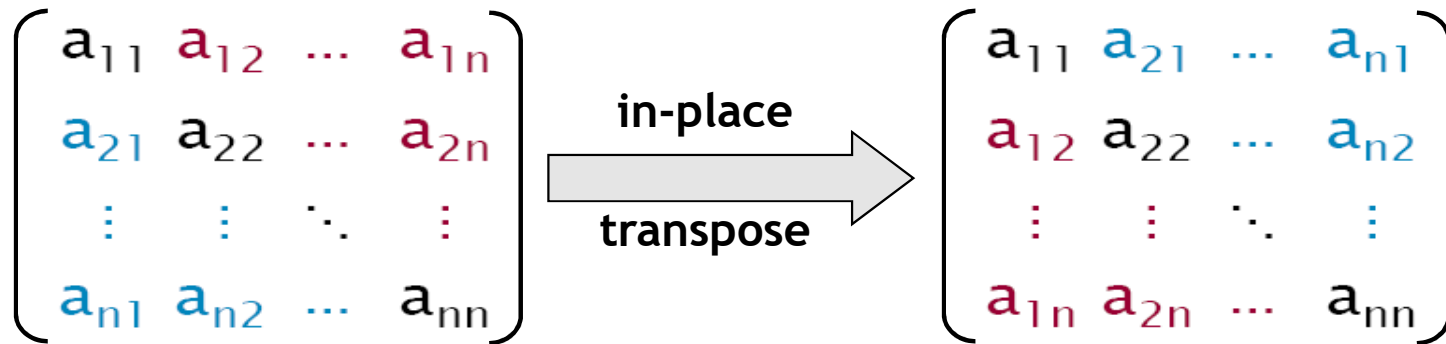

```
for ( int i = 1; i < n; ++i )
  for ( int j = 0; j < i; ++j )
  {
    double t = A[ i ][ j ];
    A[ i ][ j ] = A[ j ][ i ];
    A[ j ][ i ] = t;
  }
```

Allows all iterations of the loop to be executed in parallel.

Can be converted to spawns and syncs using recursive divide-and-conquer.

Serial Code

```
parallel for ( int i = 1; i < n; ++i )
  for ( int j = 0; j < i; ++j )
  {
    double t = A[ i ][ j ];
    A[ i ][ j ] = A[ j ][ i ];
    A[ j ][ i ] = t;
  }
```

Parallel Code

Recursive D&C Implementation of Parallel Loops

```
parallel for ( int i = s; i < t; ++i )  
    BODY( i );
```

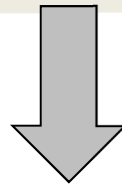

divide-and-conquer
implementation

```
void recur( int lo, int hi )  
{  
    if ( hi - lo > GRAINSIZE )  
    {  
        int mid = lo + ( hi - lo ) / 2;  
        spawn recur( lo, mid );  
        recur( mid, hi );  
        sync;  
    }  
    else  
    {  
        for ( int i = lo; i < hi; ++i )  
            BODY( i );  
    }  
}  
  
recur( s, t );
```

Analyzing Parallel Algorithms

Speedup

Let T_p = running time using p identical processing elements

$$\text{Speedup, } S_p = \frac{T_1}{T_p}$$

Theoretically, $S_p \leq p$

Perfect or linear or ideal speedup if $S_p = p$

Speedup

Consider adding n numbers using n identical processing elements.

Serial runtime, $T = \Theta(n)$

Parallel runtime, $T_n = \Theta(\log n)$

Speedup, $S_n = \frac{T_1}{T_n} = \Theta\left(\frac{n}{\log n}\right)$



(a) Initial data distribution and the first communication step

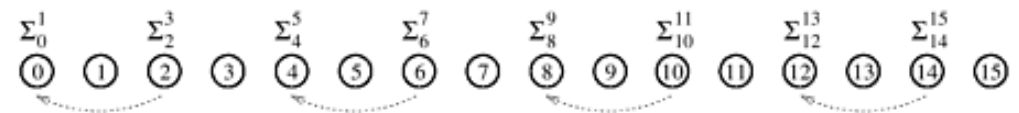

(b) Second communication step

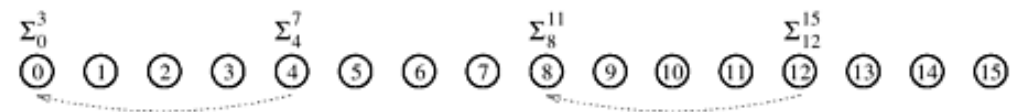

(c) Third communication step

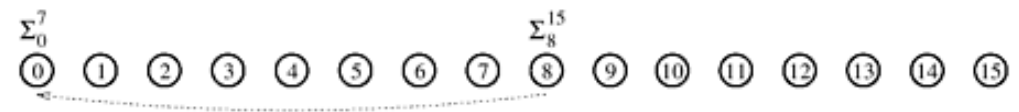

(d) Fourth communication step



(e) Accumulation of the sum at processing element 0 after the final communication

Superlinear Speedup

Theoretically, $S_p \leq p$

But in practice *superlinear speedup* is sometimes observed,
that is, $S_p > p$ (why?)

Reasons for superlinear speedup

- Cache effects
- Exploratory decomposition

Parallelism & Span Law

We defined, T_p = runtime on p identical processing elements

Then span, T_∞ = runtime on an infinite number of identical processing elements

$$\text{Parallelism, } P = \frac{T_1}{T_\infty}$$

Parallelism is an upper bound on speedup, i.e., $S_p \leq P$

Span Law

$$T_p \geq T_\infty$$

Work Law

The cost of solving (or work performed for solving) a problem:

On a Serial Computer: is given by T_1

On a Parallel Computer: is given by pT_p

Work Law

$$T_p \geq \frac{T_1}{p}$$

Bounding Parallel Running Time (T_p)

A *runtime/online scheduler* maps tasks to processing elements dynamically at runtime.

A *greedy scheduler* never leaves a processing element idle if it can map a task to it.

Theorem [Graham'68, Brent'74]: For any greedy scheduler,

$$T_p \leq \frac{T_1}{p} + T_\infty$$

Corollary: For any greedy scheduler,

$$T_p \leq 2T_p^*,$$

where T_p^* is the running time due to optimal scheduling on p processing elements.

Work Optimality

Let T_s = runtime of the optimal or the fastest known serial algorithm

A parallel algorithm is *cost-optimal* or *work-optimal* provided

$$pT_p = \Theta(T_s)$$

Our algorithm for adding n numbers using n identical processing elements is clearly not work optimal.

Adding n Numbers Work-Optimality

We reduce the number of processing elements which in turn increases the granularity of the subproblem assigned to each processing element.

Suppose we use p processing elements.

First each processing element locally

adds its $\frac{n}{p}$ numbers in time $\Theta\left(\frac{n}{p}\right)$.

Then p processing elements adds these p partial sums in time $\Theta(\log p)$.

Thus $T_p = \Theta\left(\frac{n}{p} + \log p\right)$, and $T_s = \Theta(n)$.

So the algorithm is work-optimal provided $n = \Omega(p \log p)$.

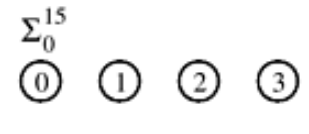
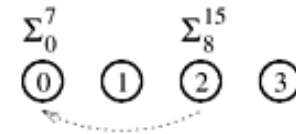
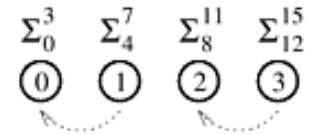
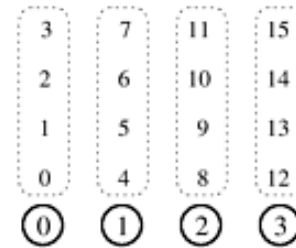

Source: Grama et al.,
"Introduction to Parallel Computing", 2nd Edition

Scaling Law

Scaling of Parallel Algorithms (Amdahl's Law)

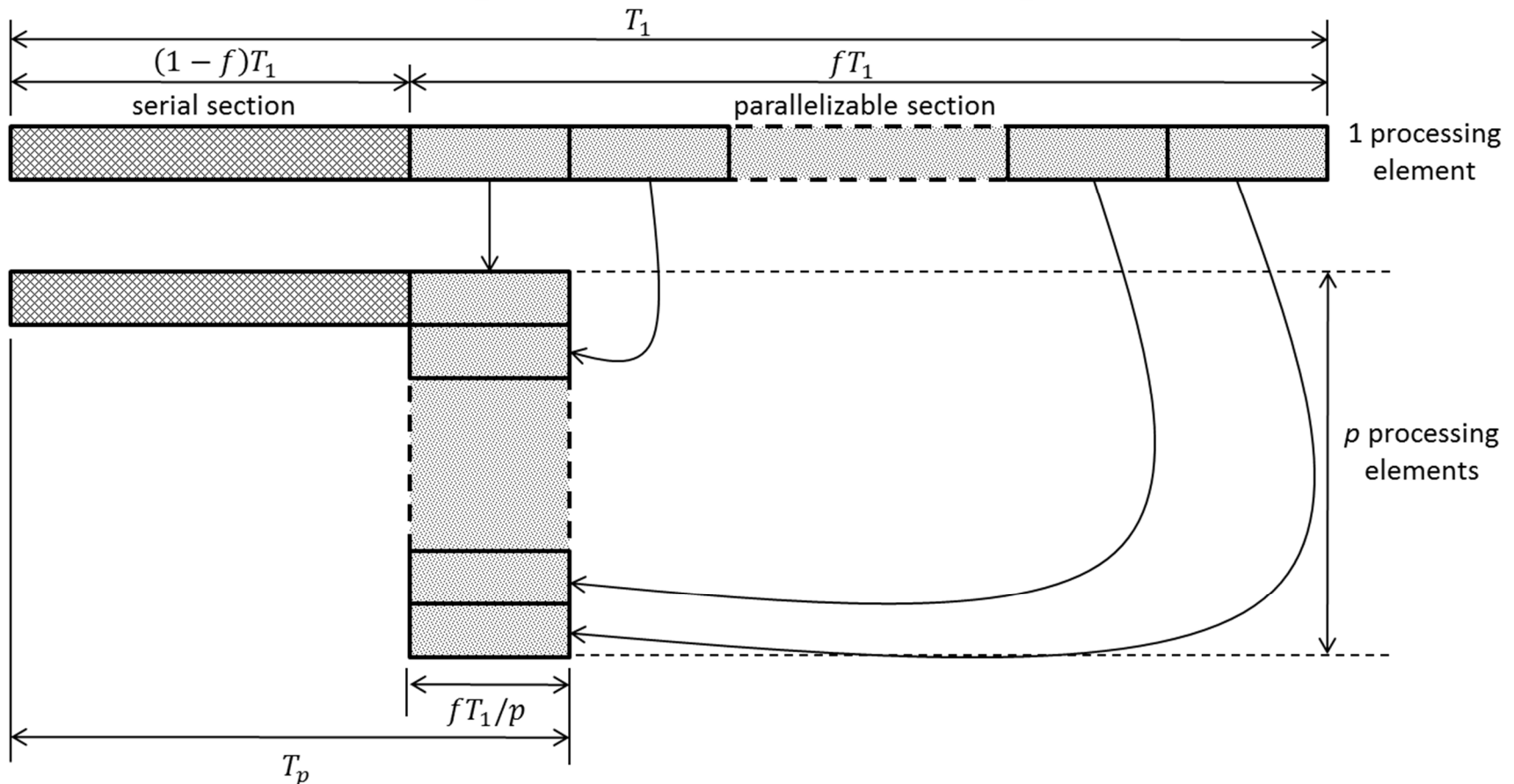

Suppose only a fraction f of a computation can be parallelized.

Then parallel running time, $T_p \geq (1-f)T_1 + f \frac{T_1}{p}$

$$\text{Speedup, } S_p = \frac{T_1}{T_p} \leq \frac{p}{f + (1-f)p} = \frac{1}{(1-f) + \frac{f}{p}} \leq \frac{1}{1-f}$$

Scaling of Parallel Algorithms (Amdahl's Law)

Suppose only a fraction f of a computation can be parallelized.

$$\text{Speedup, } S_p = \frac{T_1}{T_p} \leq \frac{1}{(1-f) + \frac{f}{p}} \leq \frac{1}{1-f}$$

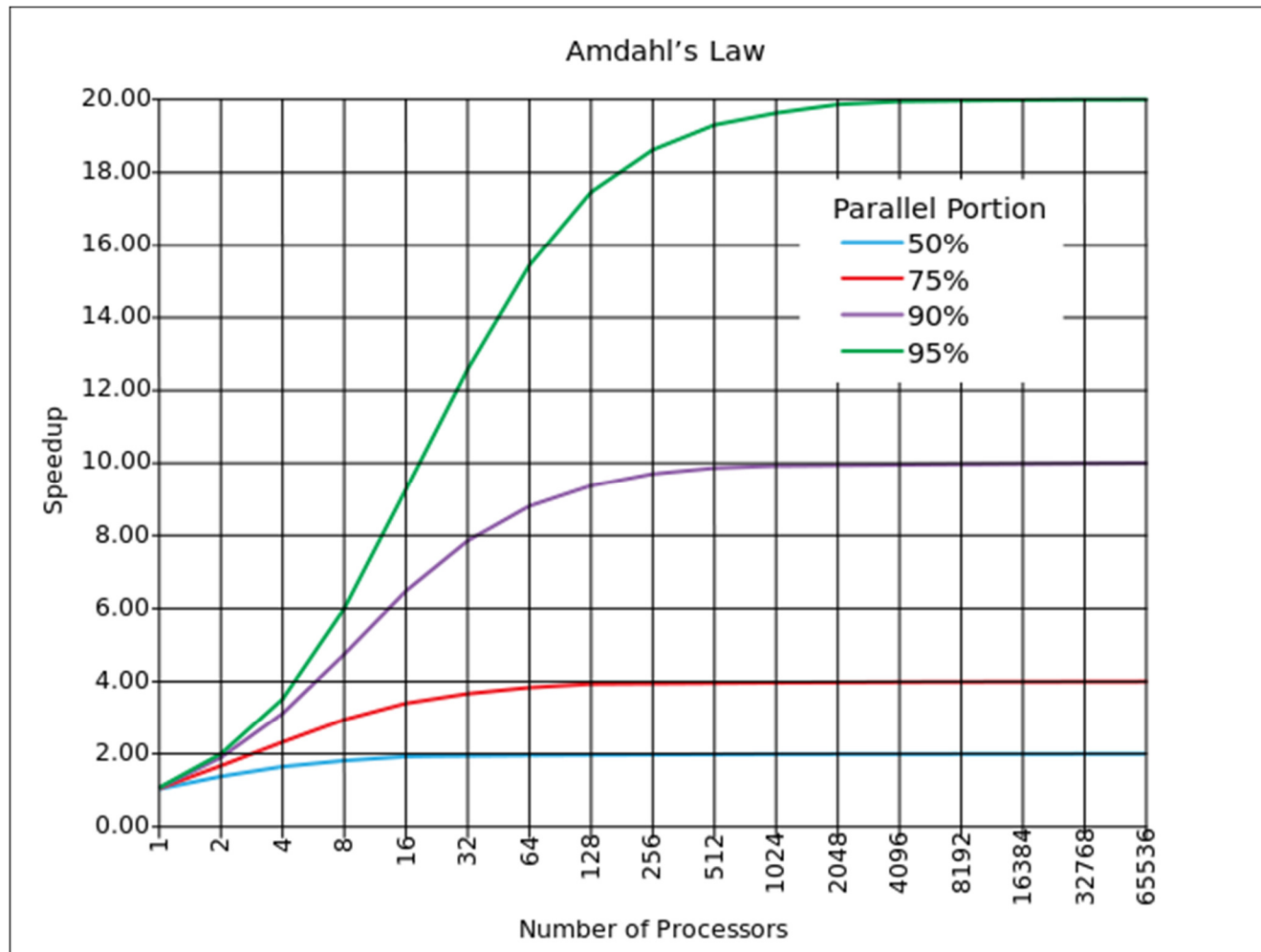

Source: Wikipedia

Strong Scaling vs. Weak Scaling

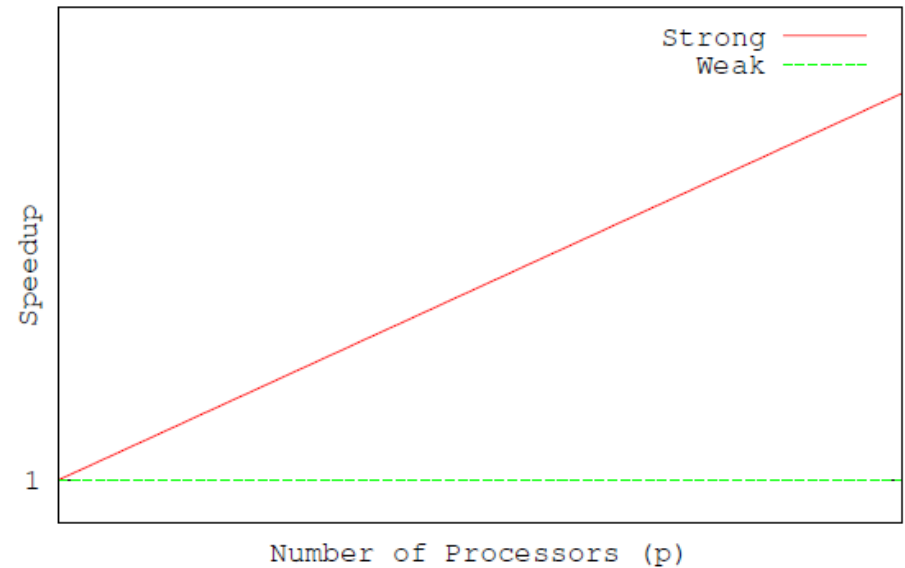
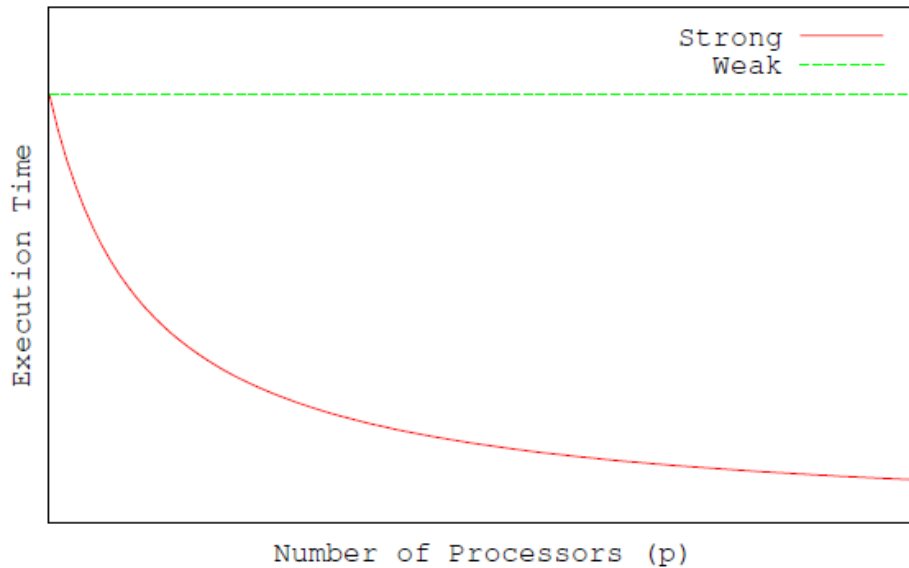

Strong Scaling

How T_p (or S_p) varies with p when the problem size is fixed.

Weak Scaling

How T_p (or S_p) varies with p when the problem size per processing element is fixed.

Scalable Parallel Algorithms

Efficiency, $E_p = \frac{S_p}{p} = \frac{T_1}{pT_p}$

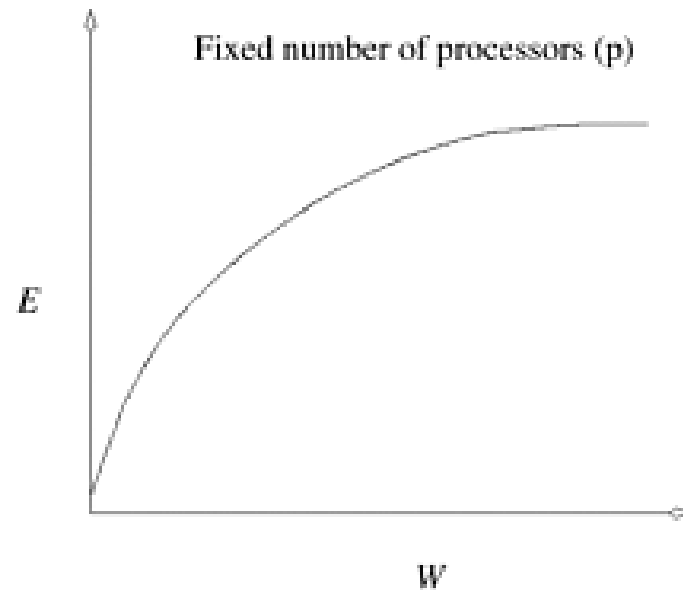
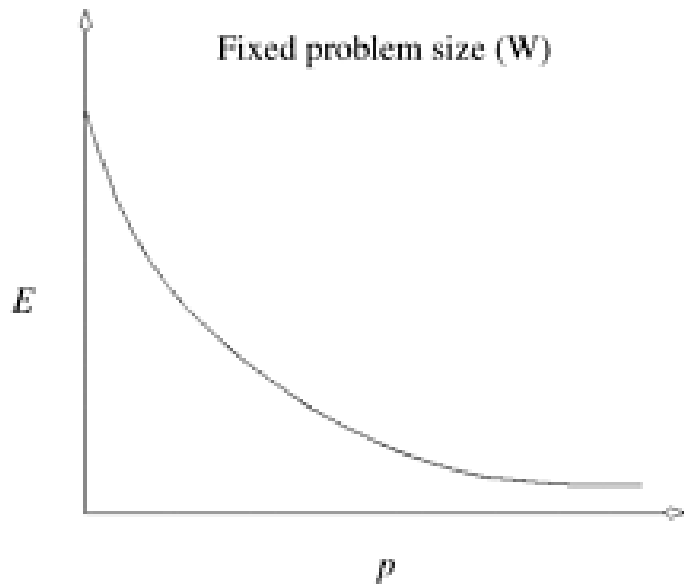

Source: Grama et al.,
"Introduction to Parallel Computing",
2nd Edition

A parallel algorithm is called *scalable* if its efficiency can be maintained at a fixed value by simultaneously increasing the number of processing elements and the problem size.

Scalability reflects a parallel algorithm's ability to utilize increasing processing elements effectively.

Races

Race Bugs

A *determinacy race* occurs if two logically parallel instructions access the same memory location and at least one of them performs a write.

```
int x = 0;  
parallel for ( int i = 0; i < 2; i++ )  
    x++;  
printf( "%d", x );
```

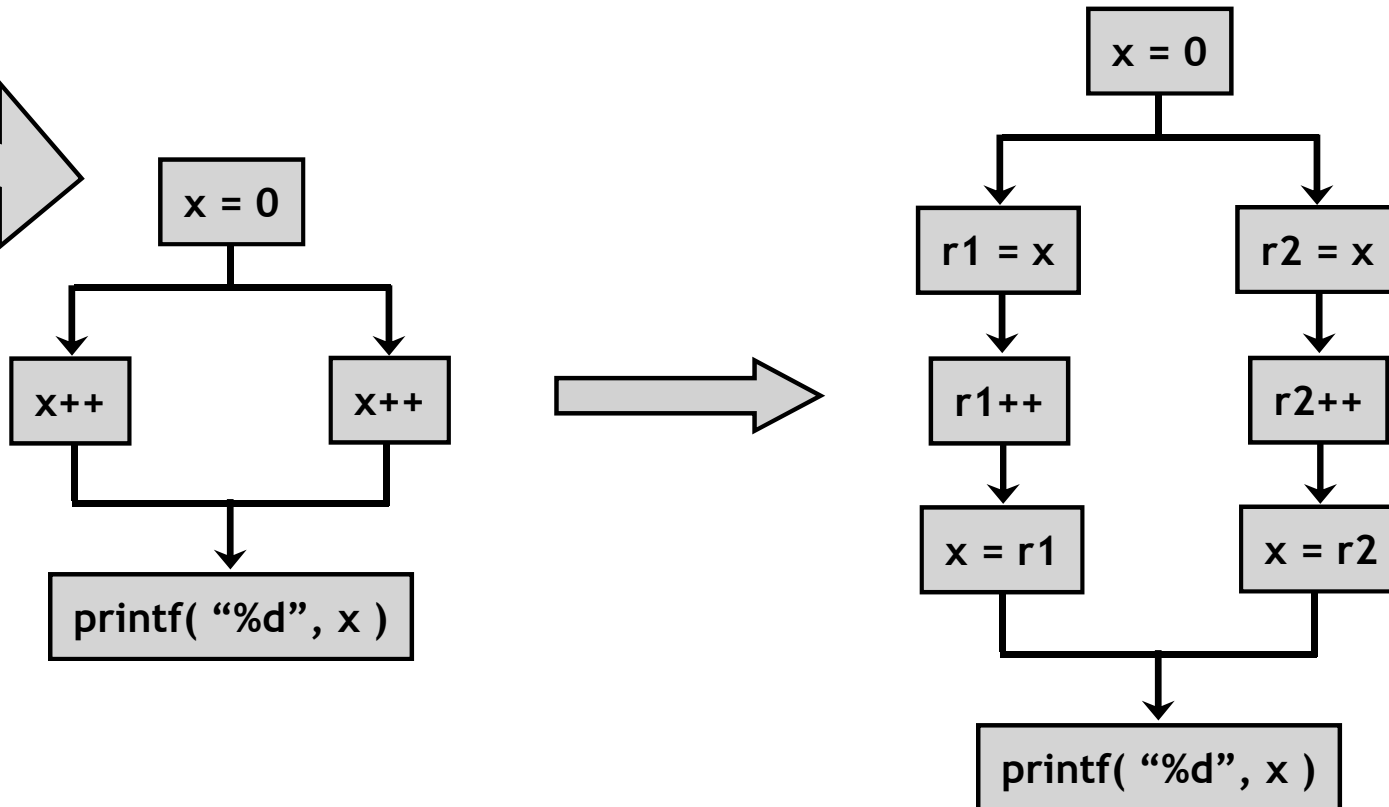

Critical Sections and Mutexes

```
int r = 0;
parallel for ( int i = 0; i < n; i++ )
    r += eval( x[ i ] );
```

race

critical section

two or more strands
must not access
at the same time

```
mutex mtx;
parallel for ( int i = 0; i < n; i++ )
    mtx.lock( );
    r += eval( x[ i ] );
    mtx.unlock( );
```

mutex (mutual exclusion)

an attempt by a strand
to lock an already locked mutex
causes that strand to block (i.e., wait)
until the mutex is unlocked

Problems

- lock overhead
- lock contention

Critical Sections and Mutexes

race

```
int r = 0;
parallel for ( int i = 0; i < n; i++ )
    r += eval( x[ i ] );
```

```
mutex mtx;

parallel for ( int i = 0; i < n; i++ )
    mtx.lock( );
    r += eval( x[ i ] );
    mtx.unlock( );
```

```
mutex mtx;

parallel for ( int i = 0; i < n; i++ )
    int y = eval( x[ i ] );
    mtx.lock( );
    r += y;
    mtx.unlock( );
```

- slightly better solution
- but lock contention can still destroy parallelism

Recursive D&C Implementation of Loops

Recursive D&C Implementation of Parallel Loops

```
parallel for ( int i = s; i < t; ++i )  
    BODY( i );
```

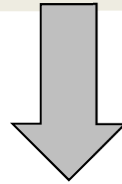

divide-and-conquer
implementation

```
void recur( int lo, int hi )  
{  
    if ( hi - lo > GRAINSIZE )  
    {  
        int mid = lo + ( hi - lo ) / 2;  
        spawn recur( lo, mid );  
        recur( mid, hi );  
        sync;  
    }  
    else  
    {  
        for ( int i = lo; i < hi; ++i )  
            BODY( i );  
    }  
}  
  
recur( s, t );
```

Let $n = t - s$

m = running time of a single call to BODY

Span: $T_{\infty}(n) = \Theta(\log n + \text{GRAINSIZE} \times m)$

Parallel Iterative MM

Iter-MM (Z, X, Y) { X, Y, Z are $n \times n$ matrices,
where n is a positive integer }

1. *for* $i \leftarrow 1$ *to* n *do*
2. *for* $j \leftarrow 1$ *to* n *do*
3. $Z[i][j] \leftarrow 0$
4. *for* $k \leftarrow 1$ *to* n *do*
5. $Z[i][j] \leftarrow Z[i][j] + X[i][k] \cdot Y[k][j]$

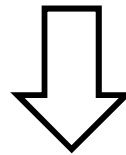

Par-Iter-MM (Z, X, Y) { X, Y, Z are $n \times n$ matrices,
where n is a positive integer }

1. *parallel for* $i \leftarrow 1$ *to* n *do*
2. *parallel for* $j \leftarrow 1$ *to* n *do*
3. $Z[i][j] \leftarrow 0$
4. *for* $k \leftarrow 1$ *to* n *do*
5. $Z[i][j] \leftarrow Z[i][j] + X[i][k] \cdot Y[k][j]$

Parallel Iterative MM

Par-Iter-MM (Z, X, Y) { X, Y, Z are $n \times n$ matrices,
where n is a positive integer }

1. *parallel for* $i \leftarrow 1$ *to* n *do*
2. *parallel for* $j \leftarrow 1$ *to* n *do*
3. $Z[i][j] \leftarrow 0$
4. *for* $k \leftarrow 1$ *to* n *do*
5. $Z[i][j] \leftarrow Z[i][j] + X[i][k] \cdot Y[k][j]$

Work: $T_1(n) = \Theta(n^3)$

Span: $T_\infty(n) = \Theta(n)$

Parallel Running Time: $T_p(n) = O\left(\frac{T_1(n)}{p} + T_\infty(n)\right) = O\left(\frac{n^3}{p} + n\right)$

Parallelism: $\frac{T_1(n)}{T_\infty(n)} = \Theta(n^2)$

Parallel Recursive MM

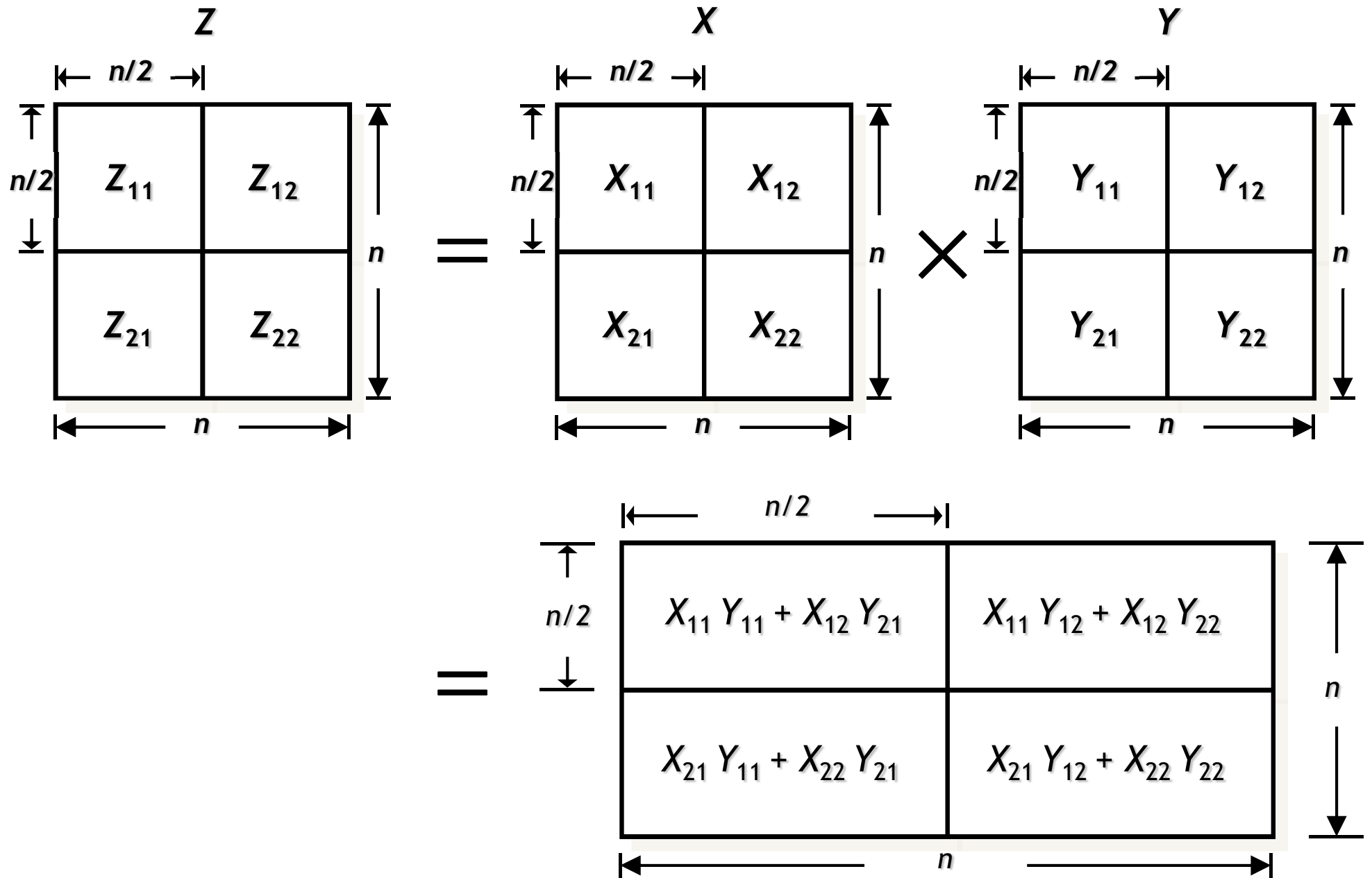

Parallel Recursive MM

Par-Rec-MM (Z, X, Y) { X, Y, Z are $n \times n$ matrices,
where $n = 2^k$ for integer $k \geq 0$ }

1. *if* $n = 1$ *then*
2. $Z \leftarrow Z + X \cdot Y$
3. *else*
4. *spawn* *Par-Rec-MM* (Z_{11}, X_{11}, Y_{11})
5. *spawn* *Par-Rec-MM* (Z_{12}, X_{11}, Y_{12})
6. *spawn* *Par-Rec-MM* (Z_{21}, X_{21}, Y_{11})
7. *Par-Rec-MM* (Z_{21}, X_{21}, Y_{12})
8. *sync*
9. *spawn* *Par-Rec-MM* (Z_{11}, X_{12}, Y_{21})
10. *spawn* *Par-Rec-MM* (Z_{12}, X_{12}, Y_{22})
11. *spawn* *Par-Rec-MM* (Z_{21}, X_{22}, Y_{21})
12. *Par-Rec-MM* (Z_{22}, X_{22}, Y_{22})
13. *sync*
14. *endif*

Recursive MM with More Parallelism

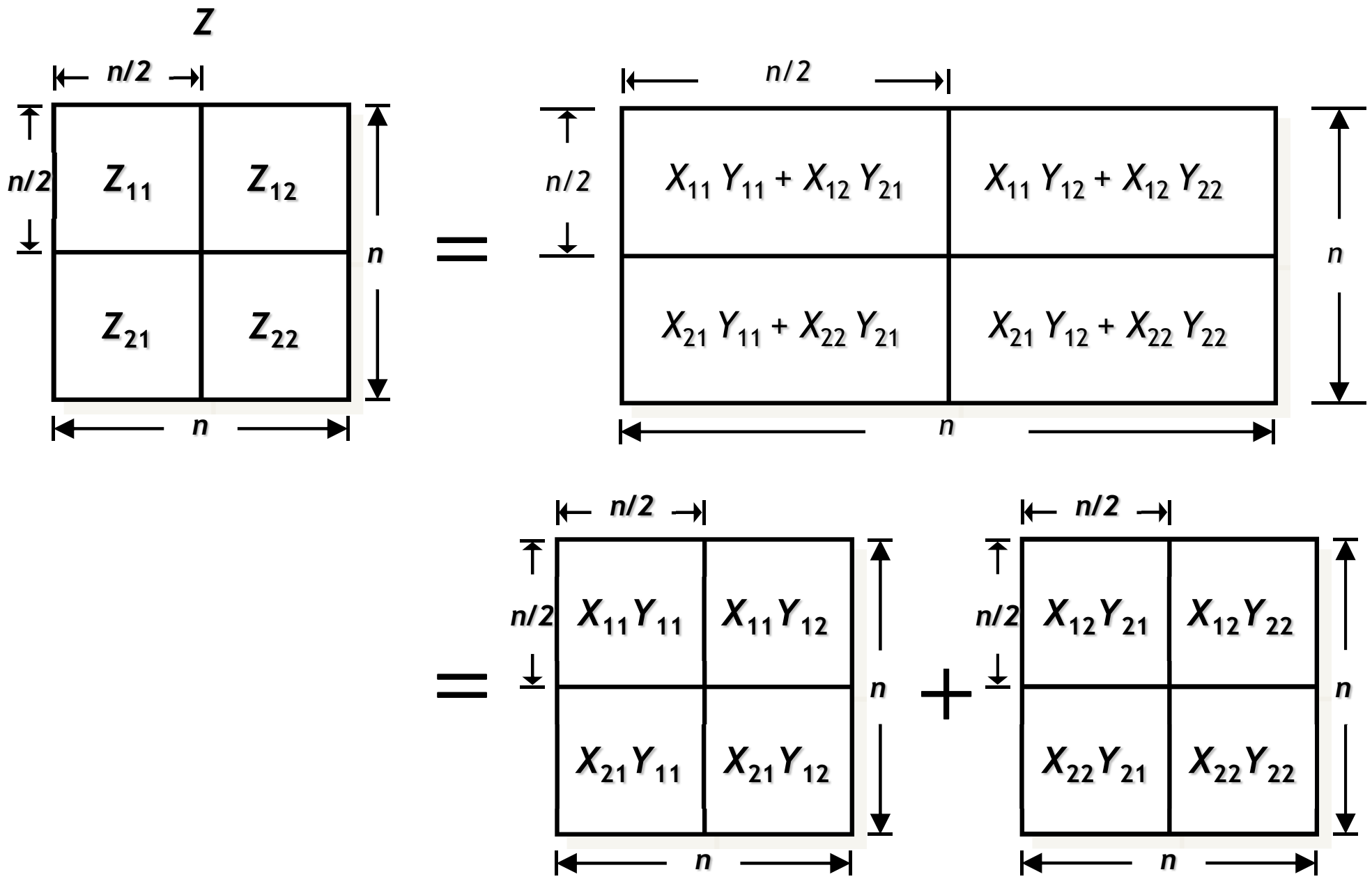

Recursive MM with More Parallelism

```
Par-Rec-MM2 ( Z, X, Y )   { X, Y, Z are  $n \times n$  matrices,  
                           where  $n = 2^k$  for integer  $k \geq 0$  }  
  
1. if  $n = 1$  then  
2.    $Z \leftarrow Z + X \cdot Y$   
3. else           {  $T$  is a temporary  $n \times n$  matrix }  
  
4.   spawn Par-Rec-MM2 (  $Z_{11}$ ,  $X_{11}$ ,  $Y_{11}$  )  
5.   spawn Par-Rec-MM2 (  $Z_{12}$ ,  $X_{11}$ ,  $Y_{12}$  )  
6.   spawn Par-Rec-MM2 (  $Z_{21}$ ,  $X_{21}$ ,  $Y_{11}$  )  
7.   spawn Par-Rec-MM2 (  $Z_{21}$ ,  $X_{21}$ ,  $Y_{12}$  )  
8.   spawn Par-Rec-MM2 (  $T_{11}$ ,  $X_{12}$ ,  $Y_{21}$  )  
9.   spawn Par-Rec-MM2 (  $T_{12}$ ,  $X_{12}$ ,  $Y_{22}$  )  
10.  spawn Par-Rec-MM2 (  $T_{21}$ ,  $X_{22}$ ,  $Y_{21}$  )  
11.      Par-Rec-MM2 (  $T_{22}$ ,  $X_{22}$ ,  $Y_{22}$  )  
12.  sync  
13.  parallel for  $i \leftarrow 1$  to  $n$  do  
14.    parallel for  $j \leftarrow 1$  to  $n$  do  
15.       $Z[i][j] \leftarrow Z[i][j] + T[i][j]$   
16.  endif
```

Recursive MM with More Parallelism

Par-Rec-MM2 (Z, X, Y) { X, Y, Z are $n \times n$ matrices,
where $n = 2^k$ for integer $k \geq 0$ }

1. *if* $n = 1$ *then*
2. $Z \leftarrow Z + X \cdot Y$
3. *else* { T is a temporary $n \times n$ matrix }
4. *spawn* *Par-Rec-MM2* (Z_{11} , X_{11} , Y_{11})
5. *spawn* *Par-Rec-MM2* (Z_{12} , X_{11} , Y_{12})
6. *spawn* *Par-Rec-MM2* (Z_{21} , X_{21} , Y_{11})
7. *spawn* *Par-Rec-MM2* (Z_{21} , X_{21} , Y_{12})
8. *spawn* *Par-Rec-MM2* (T_{11} , X_{12} , Y_{21})
9. *spawn* *Par-Rec-MM2* (T_{12} , X_{12} , Y_{22})
10. *spawn* *Par-Rec-MM2* (T_{21} , X_{22} , Y_{21})
11. *Par-Rec-MM2* (T_{22} , X_{22} , Y_{22})
12. *sync*
13. *parallel for* $i \leftarrow 1$ *to* n *do*
14. *parallel for* $j \leftarrow 1$ *to* n *do*
15. $Z[i][j] \leftarrow Z[i][j] + T[i][j]$
16. *endif*

Work:

$$T_1(n) = \begin{cases} \Theta(1), & \text{if } n = 1, \\ 8T_1\left(\frac{n}{2}\right) + \Theta(n^2), & \text{otherwise.} \end{cases}$$

$$= \Theta(n^3) \quad [\text{MT Case 1}]$$

Span:

$$T_\infty(n) = \begin{cases} \Theta(1), & \text{if } n = 1, \\ T_\infty\left(\frac{n}{2}\right) + \Theta(\log n), & \text{otherwise.} \end{cases}$$

$$= \Theta(\log^2 n) \quad [\text{MT Case 2}]$$

Parallelism: $\frac{T_1(n)}{T_\infty(n)} = \Theta\left(\frac{n^3}{\log^2 n}\right)$

Additional Space:

$$s_\infty(n) = \begin{cases} \Theta(1), & \text{if } n = 1, \\ 8s_\infty\left(\frac{n}{2}\right) + \Theta(n^2), & \text{otherwise.} \end{cases}$$

$$= \Theta(n^3) \quad [\text{MT Case 1}]$$

Parallel Merge Sort

Parallel Merge Sort

Merge-Sort (A, p, r) { sort the elements in $A[p \dots r]$ }

1. *if* $p < r$ *then*
2. $q \leftarrow \lfloor (p+r) / 2 \rfloor$
3. *Merge-Sort* (A, p, q)
4. *Merge-Sort* ($A, q+1, r$)
5. *Merge* (A, p, q, r)

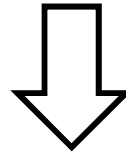

Par-Merge-Sort (A, p, r) { sort the elements in $A[p \dots r]$ }

1. *if* $p < r$ *then*
2. $q \leftarrow \lfloor (p+r) / 2 \rfloor$
3. *spawn* *Merge-Sort* (A, p, q)
4. *Merge-Sort* ($A, q+1, r$)
5. *sync*
6. *Merge* (A, p, q, r)

Parallel Merge Sort

Par-Merge-Sort (A, p, r) { sort the elements in $A[p \dots r]$ }

1. *if* $p < r$ *then*
2. $q \leftarrow \lfloor (p+r) / 2 \rfloor$
3. *spawn* *Merge-Sort* (A, p, q)
4. *Merge-Sort* ($A, q+1, r$)
5. *sync*
6. *Merge* (A, p, q, r)

$$\text{Work: } T_1(n) = \begin{cases} \Theta(1), & \text{if } n = 1, \\ 2T_1\left(\frac{n}{2}\right) + \Theta(n), & \text{otherwise.} \end{cases}$$

$$= \Theta(n \log n) \quad [\text{MT Case 2}]$$

$$\text{Span: } T_\infty(n) = \begin{cases} \Theta(1), & \text{if } n = 1, \\ T_\infty\left(\frac{n}{2}\right) + \Theta(n), & \text{otherwise.} \end{cases}$$

$$= \Theta(n) \quad [\text{MT Case 3}]$$

$$\text{Parallelism: } \frac{T_1(n)}{T_\infty(n)} = \Theta(\log n)$$

Parallel Merge

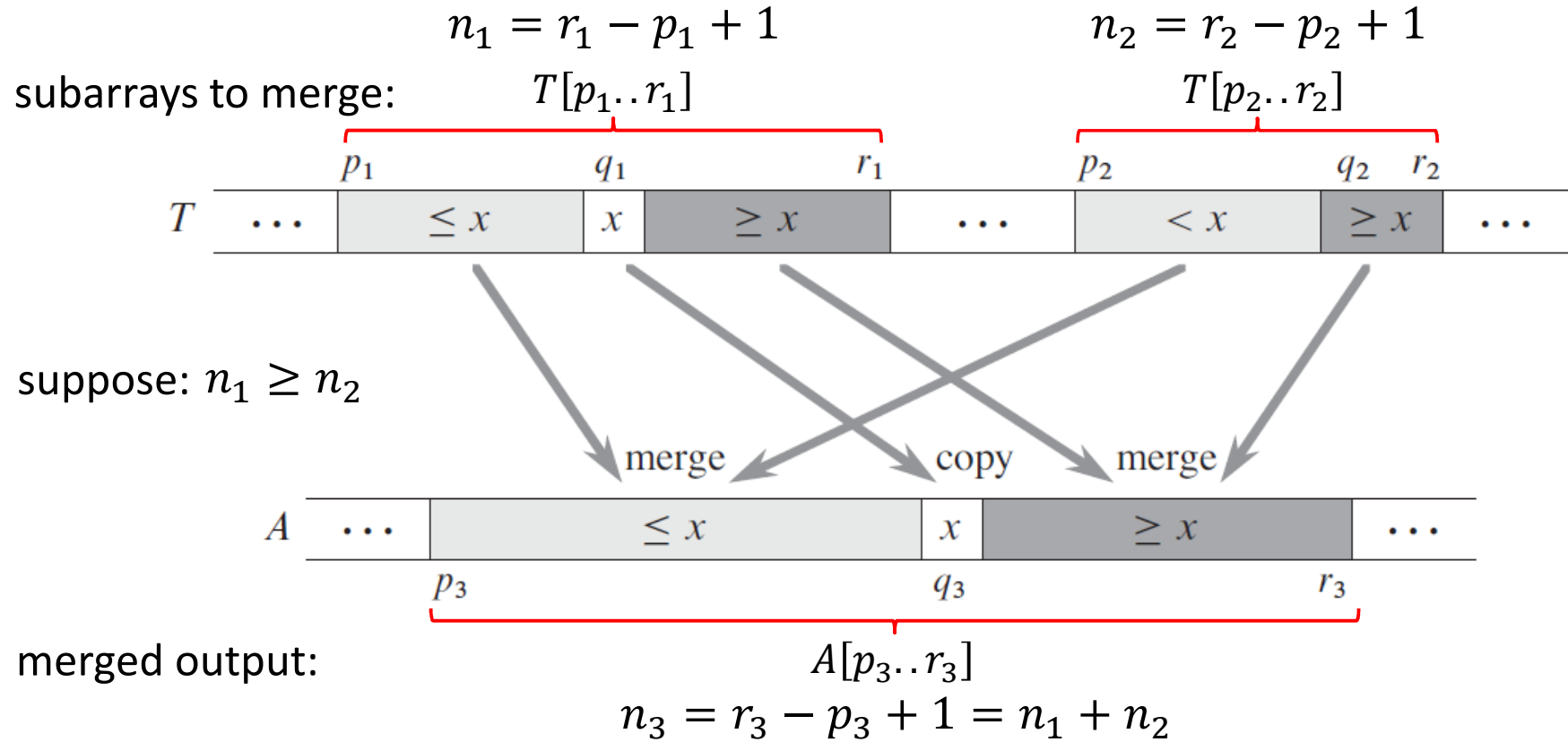

Source: Cormen et al.,
 "Introduction to Algorithms",
 3rd Edition

Parallel Merge

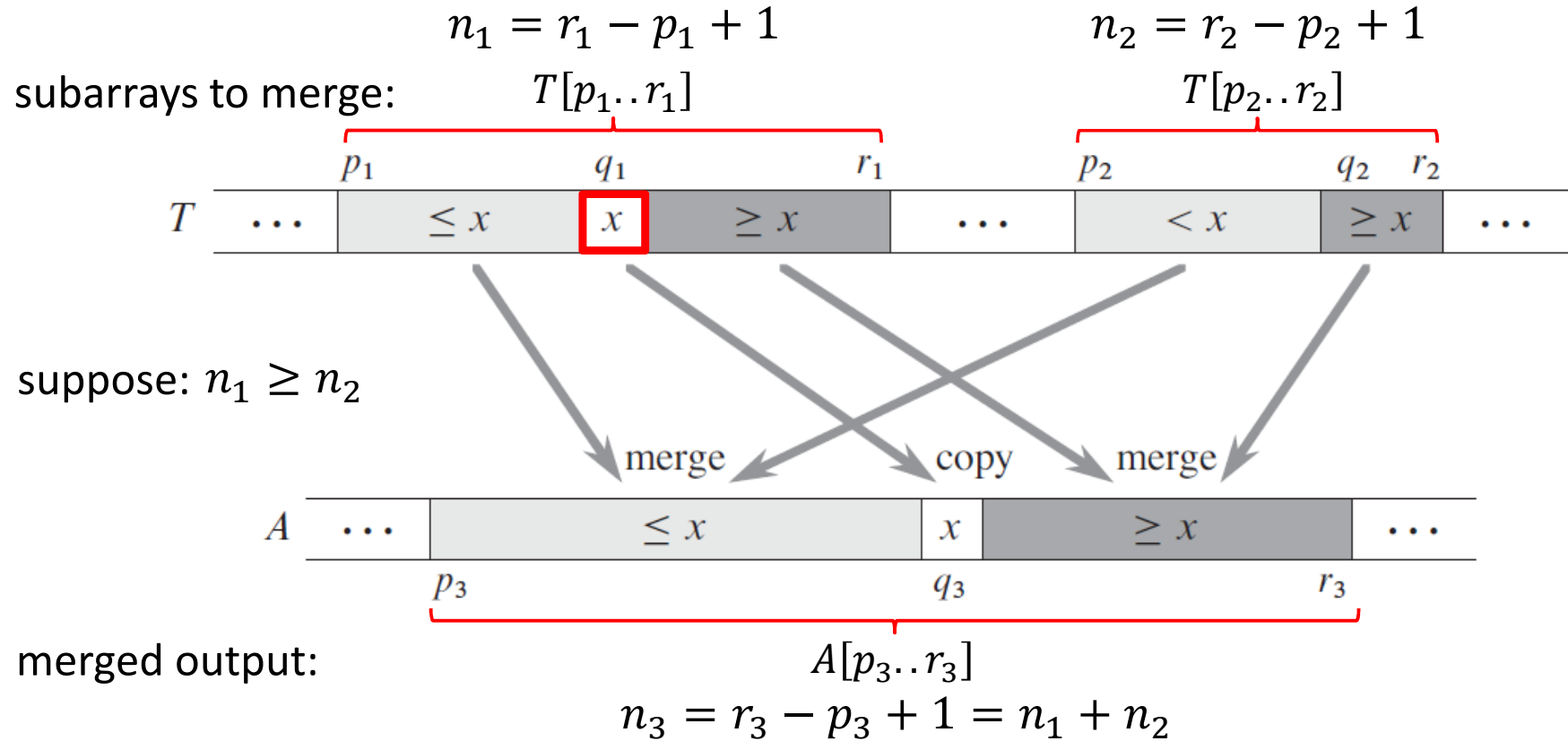

Source: Cormen et al.,
 "Introduction to Algorithms",
 3rd Edition

Step 1: Find $x = T[q_1]$, where q_1 is the midpoint of $T[p_1..r_1]$

Parallel Merge

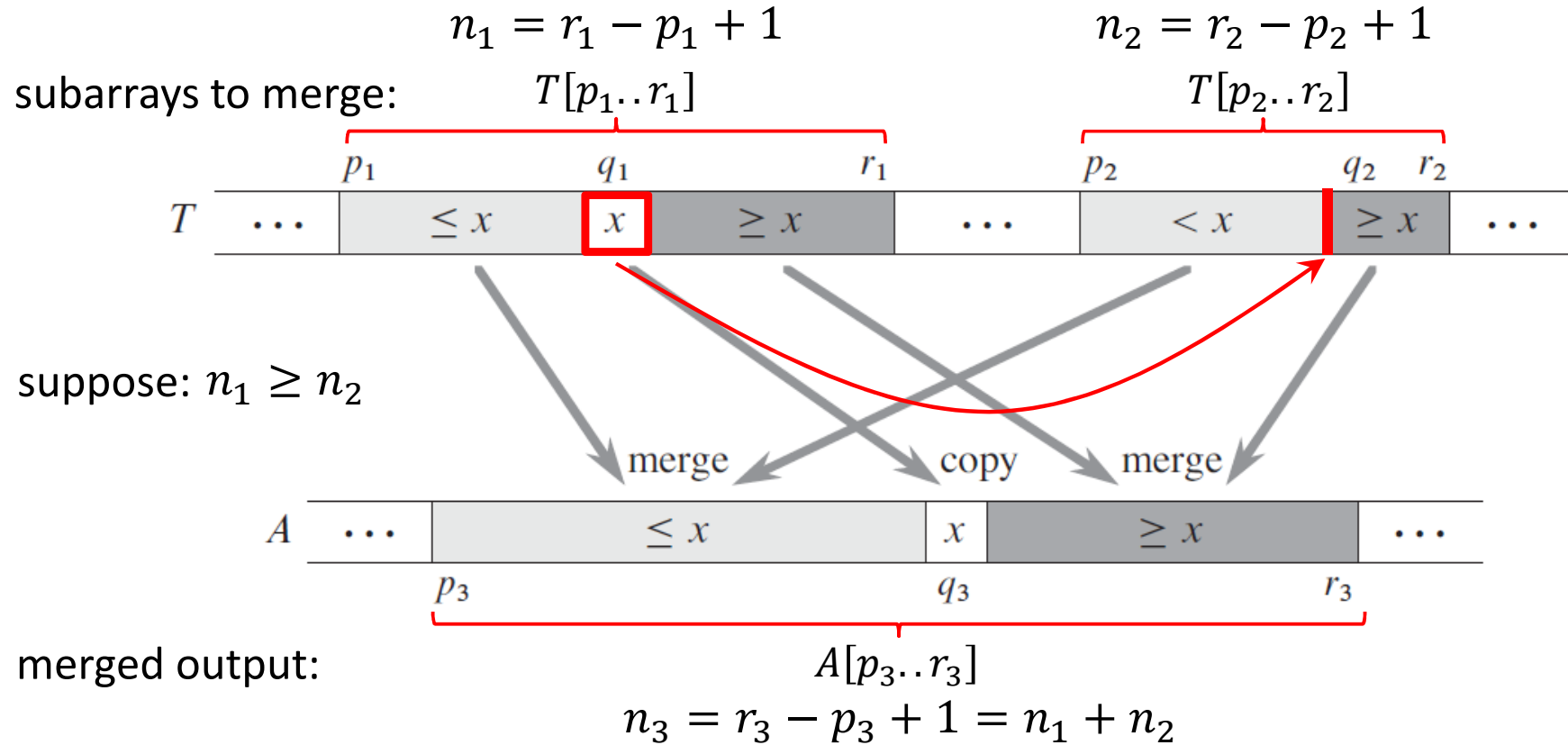

Source: Cormen et al.,
 "Introduction to Algorithms",
 3rd Edition

Step 2: Use binary search to find the index q_2 in subarray $T[p_2..r_2]$ so that the subarray would still be sorted if we insert x between $T[q_2 - 1]$ and $T[q_2]$

Parallel Merge

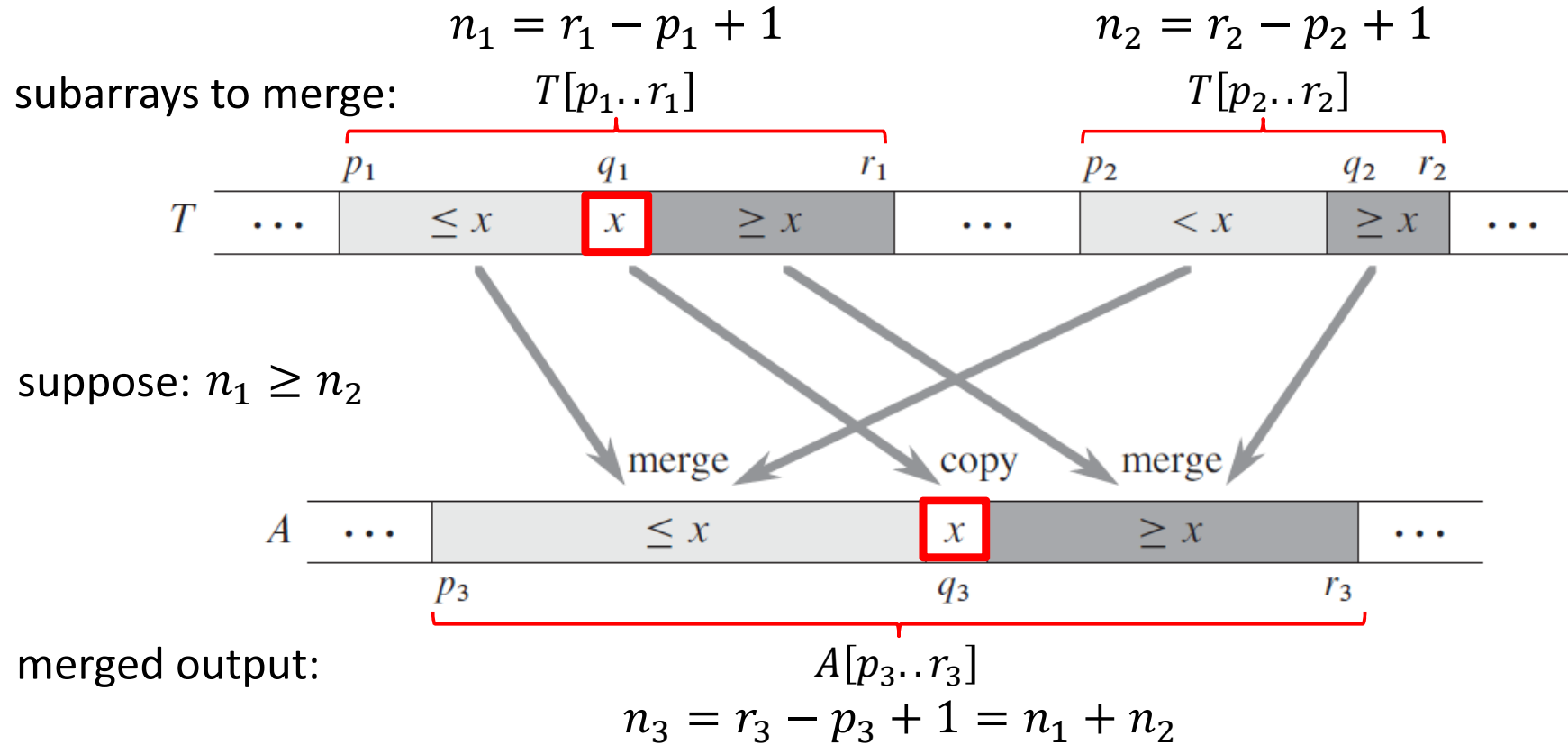

Source: Cormen et al.,
 "Introduction to Algorithms",
 3rd Edition

Step 3: Copy x to $A[q_3]$, where $q_3 = p_3 + (q_1 - p_1) + (q_2 - p_2)$

Parallel Merge

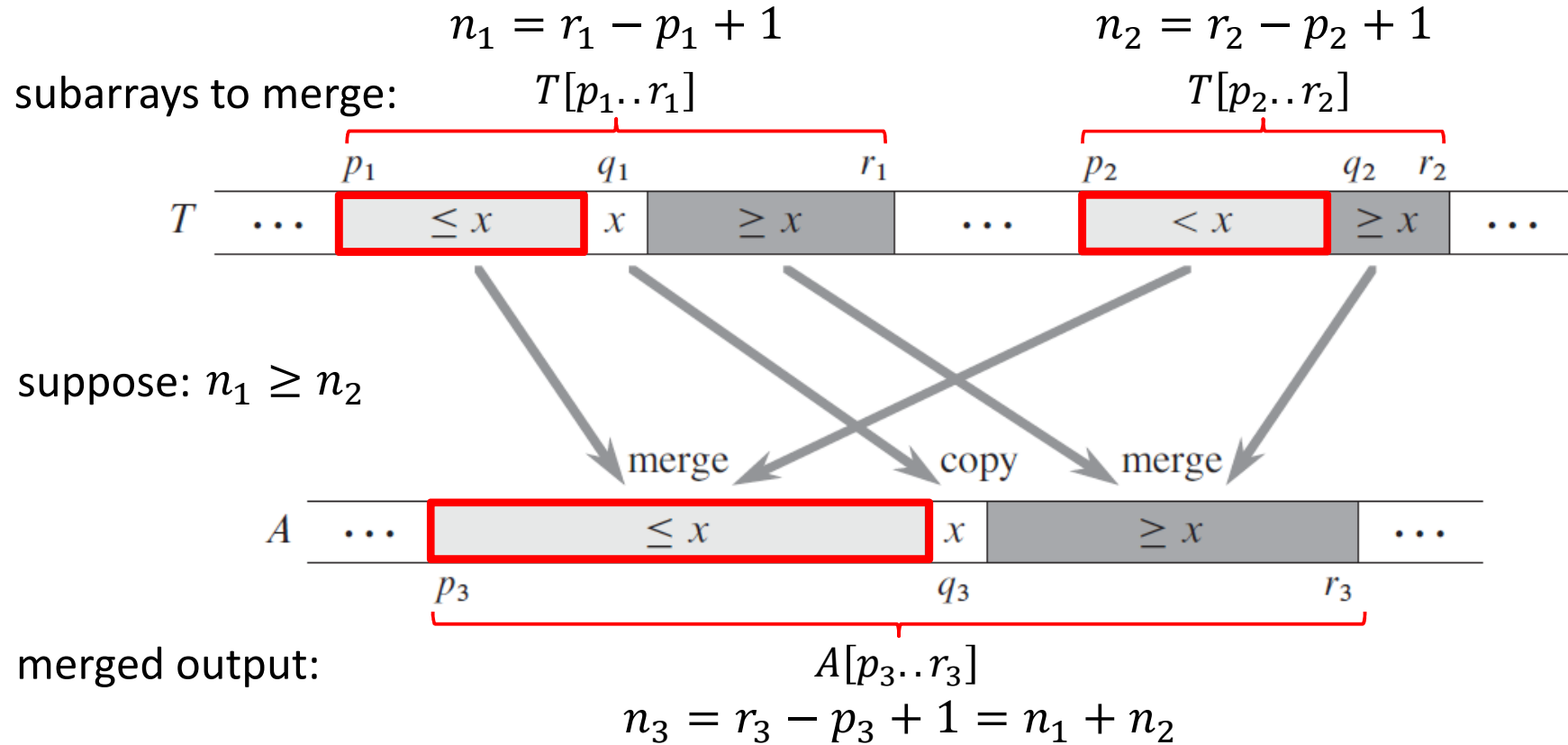

Source: Cormen et al.,
 "Introduction to Algorithms",
 3rd Edition

Perform the following two steps in parallel.

Step 4(a): Recursively merge $T[p_1..q_1 - 1]$ with $T[p_2..q_2 - 1]$,
 and place the result into $A[p_3..q_3 - 1]$

Parallel Merge

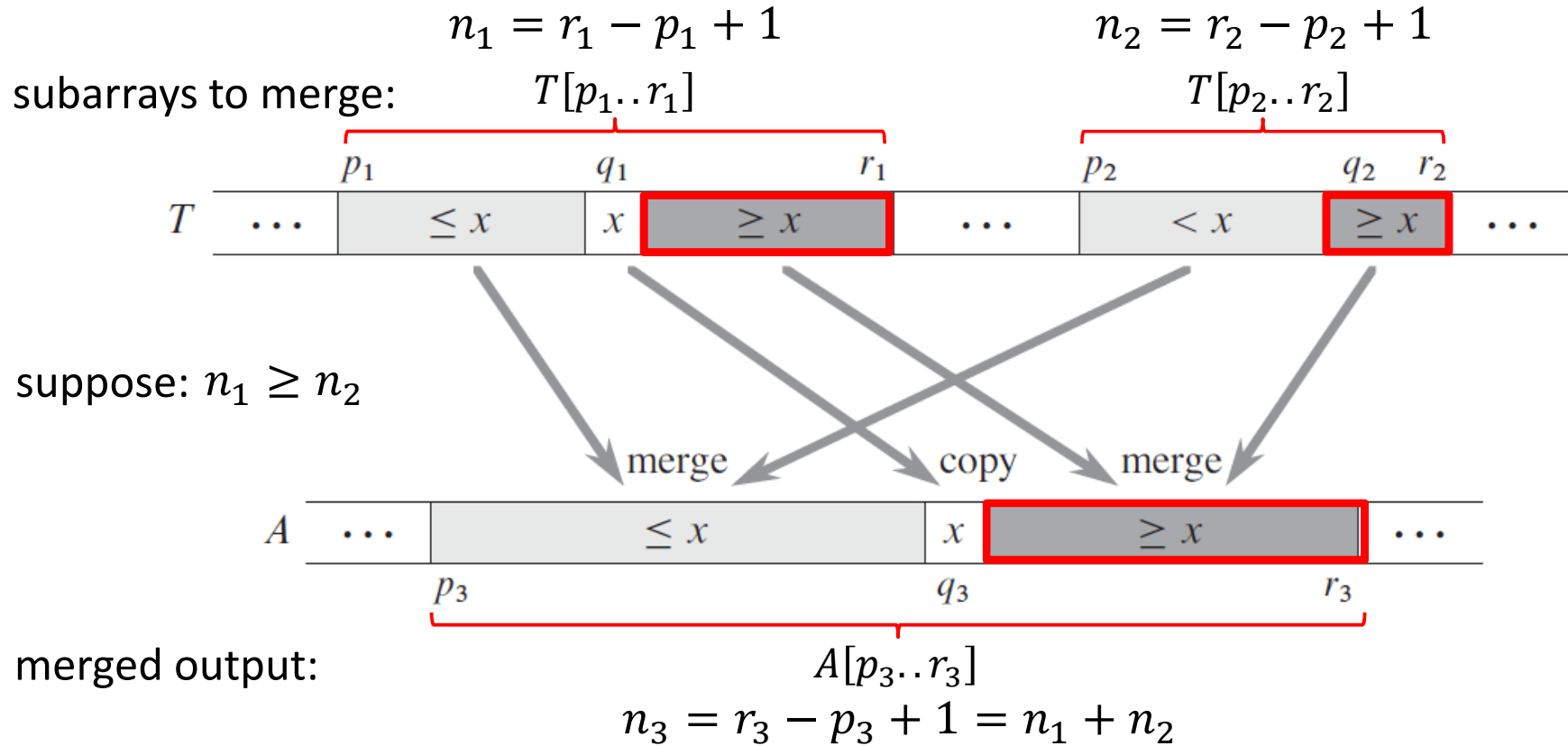

Source: Cormen et al.,
 "Introduction to Algorithms",
 3rd Edition

Perform the following two steps in parallel.

Step 4(a): Recursively merge $T[p_1..q_1 - 1]$ with $T[p_2..q_2 - 1]$,
 and place the result into $A[p_3..q_3 - 1]$

Step 4(b): Recursively merge $T[q_1 + 1..r_1]$ with $T[q_2 + 1..r_2]$,
 and place the result into $A[q_3 + 1..r_3]$

Parallel Merge

Par-Merge ($T, p_1, r_1, p_2, r_2, A, p_3$)

1. $n_1 \leftarrow r_1 - p_1 + 1, n_2 \leftarrow r_2 - p_2 + 1$
2. *if* $n_1 < n_2$ *then*
3. $p_1 \leftrightarrow p_2, r_1 \leftrightarrow r_2, n_1 \leftrightarrow n_2$
4. *if* $n_1 = 0$ *then return*
5. *else*
6. $q_1 \leftarrow \lfloor (p_1 + r_1) / 2 \rfloor$
7. $q_2 \leftarrow \text{Binary-Search} (T[q_1], T, p_2, r_2)$
8. $q_3 \leftarrow p_3 + (q_1 - p_1) + (q_2 - p_2)$
9. $A[q_3] \leftarrow T[q_1]$
10. *spawn* *Par-Merge* ($T, p_1, q_1-1, p_2, q_2-1, A, p_3$)
11. *Par-Merge* ($T, q_1+1, r_1, q_2+1, r_2, A, q_3+1$)
12. *sync*

Parallel Merge

Par-Merge ($T, p_1, r_1, p_2, r_2, A, p_3$)

1. $n_1 \leftarrow r_1 - p_1 + 1, n_2 \leftarrow r_2 - p_2 + 1$
2. *if* $n_1 < n_2$ *then*
3. $p_1 \leftrightarrow p_2, r_1 \leftrightarrow r_2, n_1 \leftrightarrow n_2$
4. *if* $n_1 = 0$ *then return*
5. *else*
6. $q_1 \leftarrow \lfloor (p_1 + r_1) / 2 \rfloor$
7. $q_2 \leftarrow \text{Binary-Search} (T[q_1], T, p_2, r_2)$
8. $q_3 \leftarrow p_3 + (q_1 - p_1) + (q_2 - p_2)$
9. $A[q_3] \leftarrow T[q_1]$
10. *spawn* *Par-Merge* ($T, p_1, q_1-1, p_2, q_2-1, A, p_3$)
11. *Par-Merge* ($T, q_1+1, r_1, q_2+1, r_2, A, q_3+1$)
12. *sync*

We have,

$$n_2 \leq n_1 \Rightarrow 2n_2 \leq n_1 + n_2 = n$$

In the worst case, a recursive call in lines 9-10 merges half the elements of $T[p_1..r_1]$ with all elements of $T[p_2..r_2]$.

Hence, #elements involved in such a call:

$$\left\lfloor \frac{n_1}{2} \right\rfloor + n_2 \leq \frac{n_1}{2} + \frac{n_2}{2} + \frac{n_2}{2} = \frac{n_1 + n_2}{2} + \frac{2n_2}{4} \leq \frac{n}{2} + \frac{n}{4} = \frac{3n}{4}$$

Parallel Merge

Par-Merge ($T, p_1, r_1, p_2, r_2, A, p_3$)

1. $n_1 \leftarrow r_1 - p_1 + 1, n_2 \leftarrow r_2 - p_2 + 1$
2. *if* $n_1 < n_2$ *then*
3. $p_1 \leftrightarrow p_2, r_1 \leftrightarrow r_2, n_1 \leftrightarrow n_2$
4. *if* $n_1 = 0$ *then return*
5. *else*
6. $q_1 \leftarrow \lfloor (p_1 + r_1) / 2 \rfloor$
7. $q_2 \leftarrow \text{Binary-Search} (T[q_1], T, p_2, r_2)$
8. $q_3 \leftarrow p_3 + (q_1 - p_1) + (q_2 - p_2)$
9. $A[q_3] \leftarrow T[q_1]$
10. *spawn* *Par-Merge* ($T, p_1, q_1-1, p_2, q_2-1, A, p_3$)
11. $\text{Par-Merge} (T, q_1+1, r_1, q_2+1, r_2, A, q_3+1)$
12. *sync*

Span:

$$T_{\infty}(n) = \begin{cases} \Theta(1), & \text{if } n = 1, \\ T_{\infty}\left(\frac{3n}{4}\right) + \Theta(\log n), & \text{otherwise.} \end{cases}$$
$$= \Theta(\log^2 n) \quad [\text{MT Case 2}]$$

Work:

Clearly, $T_1(n) = \Omega(n)$

We show below that, $T_1(n) = O(n)$

For some $\alpha \in \left[\frac{1}{4}, \frac{3}{4}\right]$, we have the following recurrence,

$$T_1(n) = T_1(\alpha n) + T_1((1 - \alpha)n) + O(\log n)$$

Assuming $T_1(n) \leq c_1 n - c_2 \log n$ for positive constants c_1 and c_2 , and substituting on the right hand side of the above recurrence gives us: $T_1(n) \leq c_1 n - c_2 \log n = O(n)$.

Hence, $T_1(n) = \Theta(n)$.

Parallel Merge Sort with Parallel Merge

Par-Merge-Sort (A, p, r) { sort the elements in A[p ... r] }

1. *if* $p < r$ *then*
2. $q \leftarrow \lfloor (p+r) / 2 \rfloor$
3. *spawn* *Merge-Sort* (A, p, q)
4. *Merge-Sort* (A, q+1, r)
5. *sync*
6. *Par-Merge* (A, p, q, r)

$$\text{Work: } T_1(n) = \begin{cases} \Theta(1), & \text{if } n = 1, \\ 2T_1\left(\frac{n}{2}\right) + \Theta(n), & \text{otherwise.} \end{cases}$$

$$= \Theta(n \log n) \quad [\text{MT Case 2}]$$

$$\text{Span: } T_\infty(n) = \begin{cases} \Theta(1), & \text{if } n = 1, \\ T_\infty\left(\frac{n}{2}\right) + \Theta(\log^2 n), & \text{otherwise.} \end{cases}$$

$$= \Theta(\log^3 n) \quad [\text{MT Case 2}]$$

$$\text{Parallelism: } \frac{T_1(n)}{T_\infty(n)} = \Theta\left(\frac{n}{\log^2 n}\right)$$

Parallel Prefix Sums

Parallel Prefix Sums

Input: A sequence of n elements $\{x_1, x_2, \dots, x_n\}$ drawn from a set S with a binary associative operation, denoted by \oplus .

Output: A sequence of n partial sums $\{s_1, s_2, \dots, s_n\}$, where $s_i = x_1 \oplus x_2 \oplus \dots \oplus x_i$ for $1 \leq i \leq n$.

x_1	x_2	x_3	x_4	x_5	x_6	x_7	x_8
5	3	7	1	3	6	2	4

\oplus = binary addition

5	8	15	16	19	25	27	31
s_1	s_2	s_3	s_4	s_5	s_6	s_7	s_8

Parallel Prefix Sums

Prefix-Sum ($\langle x_1, x_2, \dots, x_n \rangle, \oplus$) $\{ n = 2^k \text{ for some } k \geq 0. \}$
Return prefix sums
 $\langle s_1, s_2, \dots, s_n \rangle \}$

1. *if* $n = 1$ *then*
2. $s_1 \leftarrow x_1$
3. *else*
4. *parallel for* $i \leftarrow 1$ *to* $n/2$ *do*
5. $y_i \leftarrow x_{2i-1} \oplus x_{2i}$
6. $\langle z_1, z_2, \dots, z_{n/2} \rangle \leftarrow \text{Prefix-Sum}(\langle y_1, y_2, \dots, y_{n/2} \rangle, \oplus)$
7. *parallel for* $i \leftarrow 1$ *to* n *do*
8. *if* $i = 1$ *then* $s_1 \leftarrow x_1$
9. *else if* $i = \text{even}$ *then* $s_i \leftarrow z_{i/2}$
10. *else* $s_i \leftarrow z_{(i-1)/2} \oplus x_i$
11. *return* $\langle s_1, s_2, \dots, s_n \rangle$

Parallel Prefix Sums

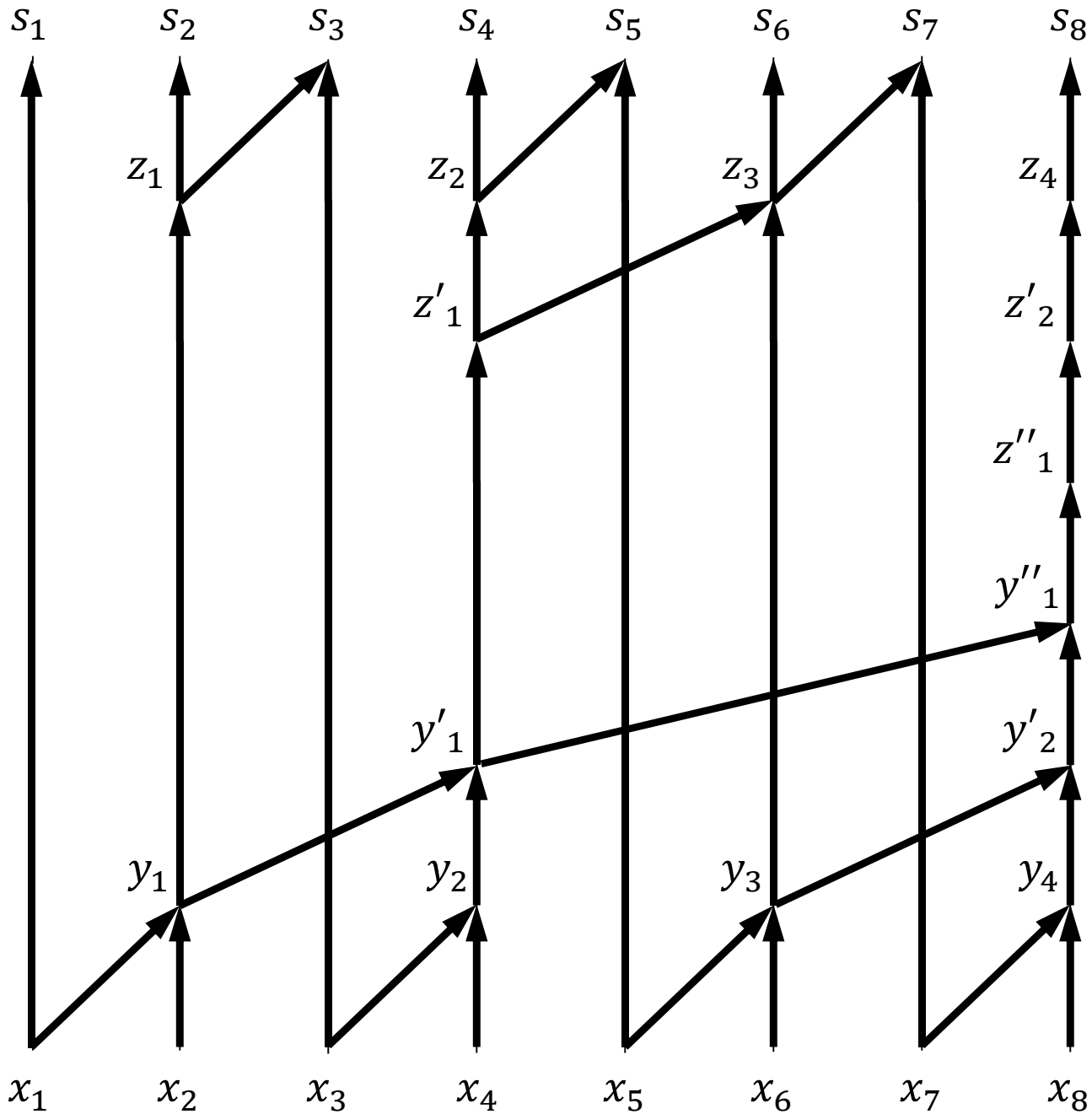

Parallel Prefix Sums

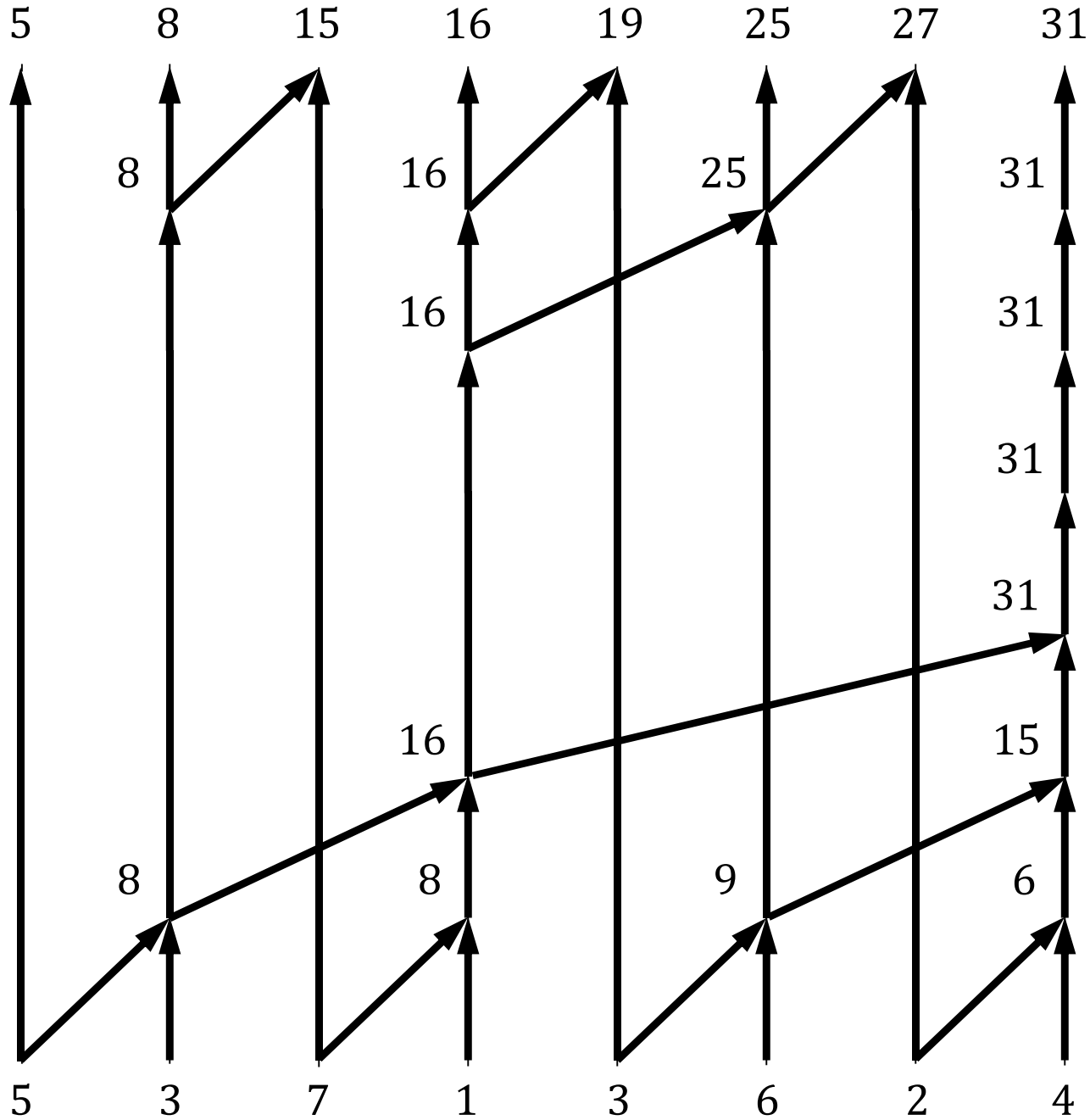

Parallel Prefix Sums

Prefix-Sum ($\langle x_1, x_2, \dots, x_n \rangle, \oplus$) $\{ n = 2^k \text{ for some } k \geq 0. \}$
 Return prefix sums
 $\langle s_1, s_2, \dots, s_n \rangle \}$

1. *if* $n = 1$ *then*
2. $s_1 \leftarrow x_1$
3. *else*
4. *parallel for* $i \leftarrow 1$ *to* $n/2$ *do*
5. $y_i \leftarrow x_{2i-1} \oplus x_{2i}$
6. $\langle z_1, z_2, \dots, z_{n/2} \rangle \leftarrow \text{Prefix-Sum}(\langle y_1, y_2, \dots, y_{n/2} \rangle, \oplus)$
7. *parallel for* $i \leftarrow 1$ *to* n *do*
8. *if* $i = 1$ *then* $s_1 \leftarrow x_1$
9. *else if* $i = \text{even}$ *then* $s_i \leftarrow z_{i/2}$
10. *else* $s_i \leftarrow z_{(i-1)/2} \oplus x_i$
11. *return* $\langle s_1, s_2, \dots, s_n \rangle$

Work:

$$T_1(n) = \begin{cases} \Theta(1), & \text{if } n = 1, \\ T_1\left(\frac{n}{2}\right) + \Theta(n), & \text{otherwise.} \end{cases}$$

$$= \Theta(n)$$

Span:

$$T_\infty(n) = \begin{cases} \Theta(1), & \text{if } n = 1, \\ T_\infty\left(\frac{n}{2}\right) + \Theta(1), & \text{otherwise.} \end{cases}$$

$$= \Theta(\log n)$$

Parallelism: $\frac{T_1(n)}{T_\infty(n)} = \Theta\left(\frac{n}{\log n}\right)$

Observe that we have assumed here that a *parallel for loop* can be executed in $\Theta(1)$ time. But recall that *cilk_for* is implemented using divide-and-conquer, and so in practice, it will take $\Theta(\log n)$ time. In that

case, we will have $T_\infty(n) = \Theta(\log^2 n)$, and parallelism = $\Theta\left(\frac{n}{\log^2 n}\right)$.

Parallel Partition

Parallel Partition

Input: An array $A[q : r]$ of distinct elements, and an element x from $A[q : r]$.

Output: Rearrange the elements of $A[q : r]$, and return an index $k \in [q, r]$, such that all elements in $A[q : k - 1]$ are smaller than x , all elements in $A[k + 1 : r]$ are larger than x , and $A[k] = x$.

```
Par-Partition (  $A[ q : r ], x$  )
1.  $n \leftarrow r - q + 1$ 
2. if  $n = 1$  then return  $q$ 
3. array  $B[ 0 : n - 1 ], lt[ 0 : n - 1 ], gt[ 0 : n - 1 ]$ 
4. parallel for  $i \leftarrow 0$  to  $n - 1$  do
5.    $B[ i ] \leftarrow A[ q + i ]$ 
6.   if  $B[ i ] < x$  then  $lt[ i ] \leftarrow 1$  else  $lt[ i ] \leftarrow 0$ 
7.   if  $B[ i ] > x$  then  $gt[ i ] \leftarrow 1$  else  $gt[ i ] \leftarrow 0$ 
8.  $lt[ 0 : n - 1 ] \leftarrow$  Par-Prefix-Sum (  $lt[ 0 : n - 1 ], +$  )
9.  $gt[ 0 : n - 1 ] \leftarrow$  Par-Prefix-Sum (  $gt[ 0 : n - 1 ], +$  )
10.  $k \leftarrow q + lt[ n - 1 ], A[ k ] \leftarrow x$ 
11. parallel for  $i \leftarrow 0$  to  $n - 1$  do
12.   if  $B[ i ] < x$  then  $A[ q + lt[ i ] - 1 ] \leftarrow B[ i ]$ 
13.   else if  $B[ i ] > x$  then  $A[ k + gt[ i ] ] \leftarrow B[ i ]$ 
14. return  $k$ 
```

Parallel Partition

A:

9	5	7	11	1	3	8	14	4	21
---	---	---	----	---	---	---	----	---	----

x = 8

Parallel Partition

A:

9	5	7	11	1	3	8	14	4	21
---	---	---	----	---	---	---	----	---	----

x = 8

B:

0	1	2	3	4	5	6	7	8	9
9	5	7	11	1	3	8	14	4	21

lt:

0	1	2	3	4	5	6	7	8	9
0	1	1	0	1	1	0	0	1	0

gt:

0	1	2	3	4	5	6	7	8	9
1	0	0	1	0	0	0	1	0	1

Parallel Partition

A:

9	5	7	11	1	3	8	14	4	21
---	---	---	----	---	---	---	----	---	----

x = 8

B:

0	1	2	3	4	5	6	7	8	9
9	5	7	11	1	3	8	14	4	21

lt:

0	1	2	3	4	5	6	7	8	9
0	1	1	0	1	1	0	0	1	0

lt:

0	1	2	2	3	4	4	4	5	5
---	---	---	---	---	---	---	---	---	---

prefix sum

gt:

0	1	2	3	4	5	6	7	8	9
1	0	0	1	0	0	0	1	0	1

gt:

1	1	1	2	2	2	2	3	3	4
---	---	---	---	---	---	---	---	---	---

prefix sum

Parallel Partition

A:

9	5	7	11	1	3	8	14	4	21
---	---	---	----	---	---	---	----	---	----

x = 8

B:

0	1	2	3	4	5	6	7	8	9
9	5	7	11	1	3	8	14	4	21

lt:

0	1	2	3	4	5	6	7	8	9
0	1	1	0	1	1	0	0	1	0

gt:

0	1	2	3	4	5	6	7	8	9
1	0	0	1	0	0	0	1	0	1

lt:

0	1	2	2	3	4	4	4	5	5
---	---	---	---	---	---	---	---	---	---

prefix sum

gt:

1	1	1	2	2	2	2	3	3	4
---	---	---	---	---	---	---	---	---	---

prefix sum

$k = 5$

A:

0	1	2	3	4	5	6	7	8	9
5	7	1	3	4	8				

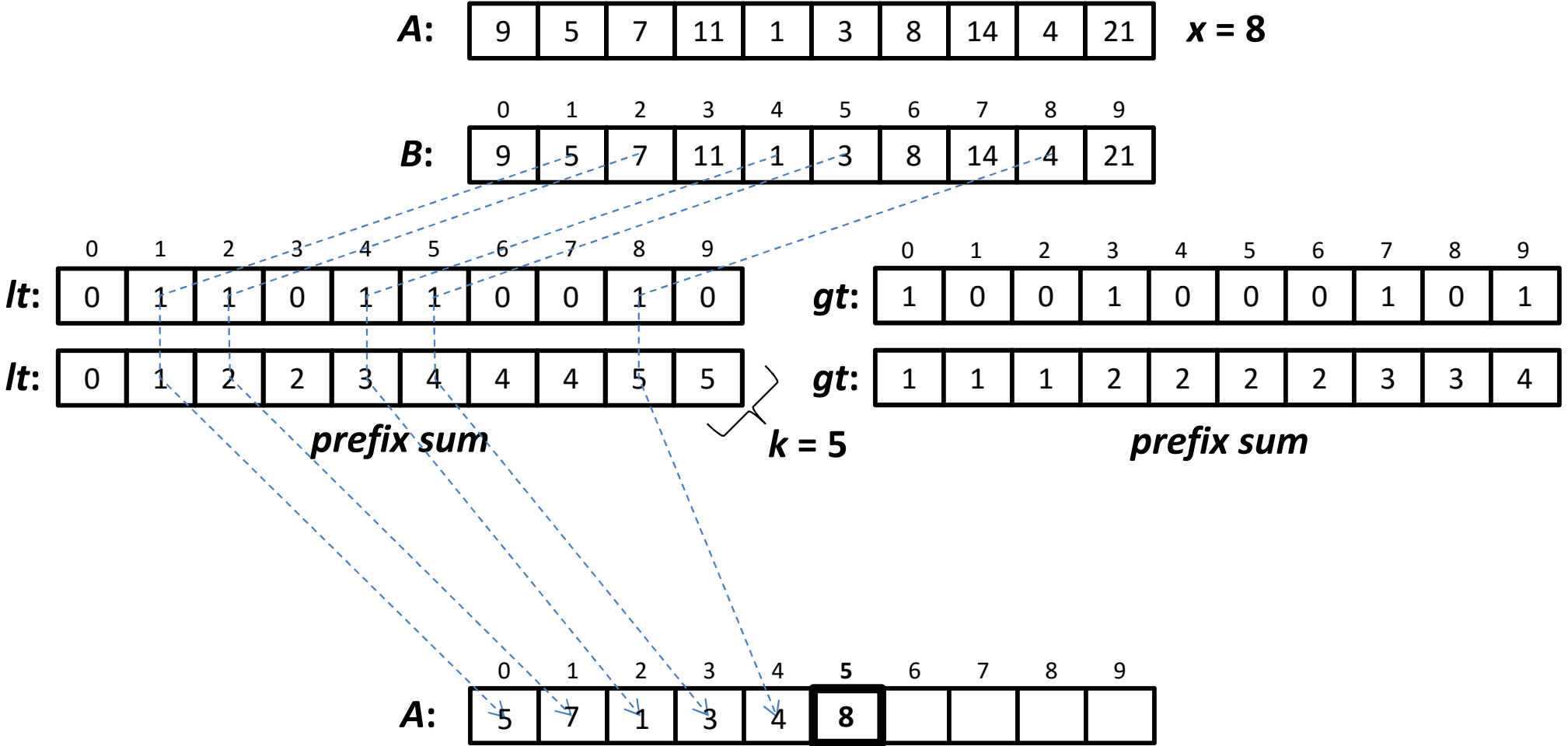

Parallel Partition

A:

9	5	7	11	1	3	8	14	4	21
---	---	---	----	---	---	---	----	---	----

x = 8

B:

0	1	2	3	4	5	6	7	8	9
9	5	7	11	1	3	8	14	4	21

lt:

0	1	2	3	4	5	6	7	8	9
0	1	1	0	1	1	0	0	1	0

lt:

0	1	2	2	3	4	4	4	5	5
---	---	---	---	---	---	---	---	---	---

prefix sum

$k = 5$

gt:

0	1	2	3	4	5	6	7	8	9
1	0	0	1	0	0	0	1	0	1

gt:

1	1	1	2	2	2	2	3	3	4
---	---	---	---	---	---	---	---	---	---

prefix sum

A:

0	1	2	3	4	5	6	7	8	9
5	7	1	3	4	8	9	11	14	21

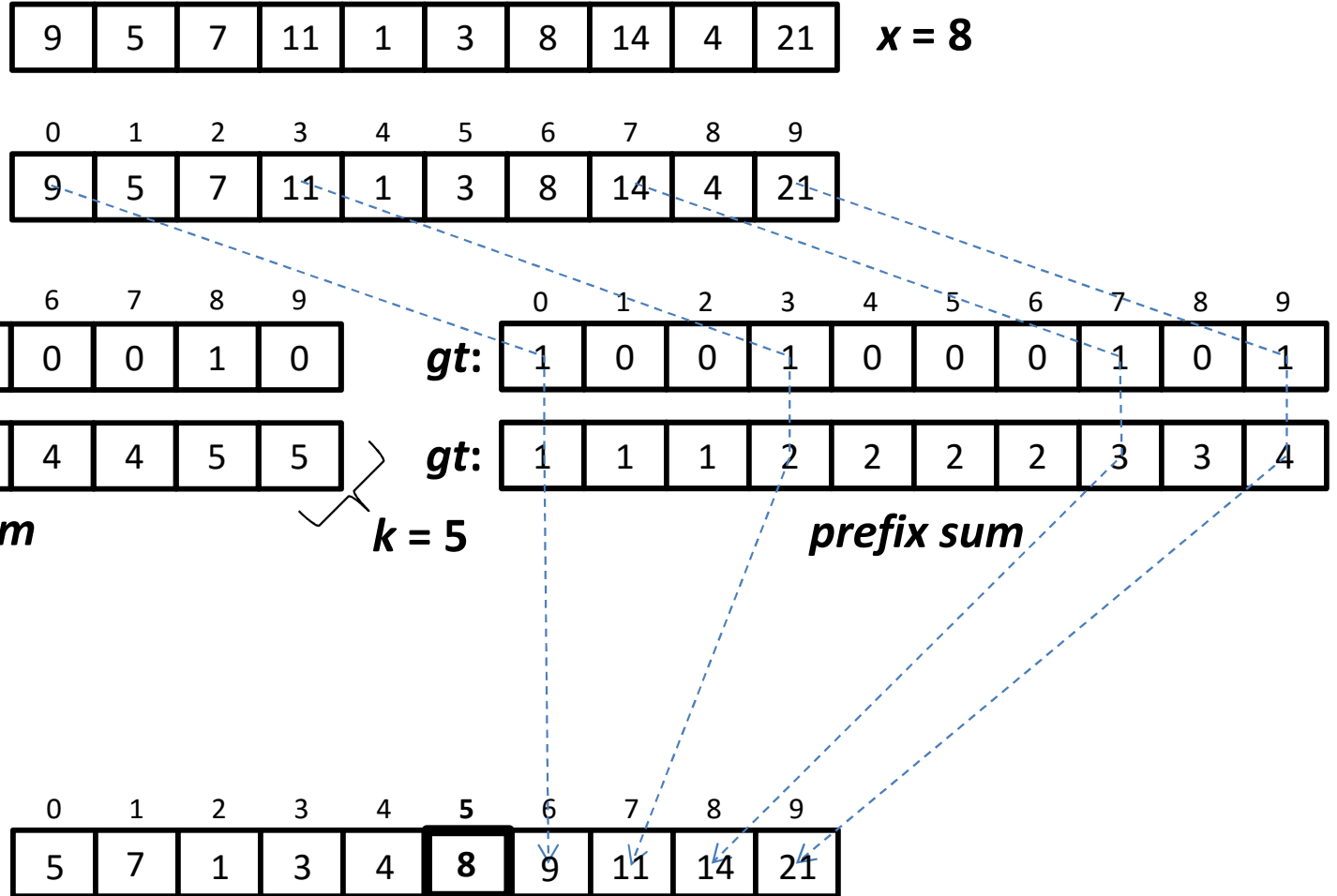

Parallel Partition

A:

9	5	7	11	1	3	8	14	4	21
---	---	---	----	---	---	---	----	---	----

x = 8

B:

0	1	2	3	4	5	6	7	8	9
9	5	7	11	1	3	8	14	4	21

lt:

0	1	2	3	4	5	6	7	8	9
0	1	1	0	1	1	0	0	1	0

gt:

0	1	2	3	4	5	6	7	8	9
1	0	0	1	0	0	0	1	0	1

lt:

0	1	2	2	3	4	4	4	5	5
---	---	---	---	---	---	---	---	---	---

gt:

1	1	1	2	2	2	2	3	3	4
---	---	---	---	---	---	---	---	---	---

prefix sum

$k = 5$

prefix sum

A:

0	1	2	3	4	5	6	7	8	9
5	7	1	3	4	8	9	11	14	21

Parallel Partition: Analysis

Par-Partition ($A[q : r]$, x)

1. $n \leftarrow r - q + 1$
2. *if* $n = 1$ *then return* q
3. *array* $B[0 : n - 1]$, $lt[0 : n - 1]$, $gt[0 : n - 1]$
4. *parallel for* $i \leftarrow 0$ *to* $n - 1$ *do*
5. $B[i] \leftarrow A[q + i]$
6. *if* $B[i] < x$ *then* $lt[i] \leftarrow 1$ *else* $lt[i] \leftarrow 0$
7. *if* $B[i] > x$ *then* $gt[i] \leftarrow 1$ *else* $gt[i] \leftarrow 0$
8. $lt[0 : n - 1] \leftarrow$ *Par-Prefix-Sum* ($lt[0 : n - 1]$, $+$)
9. $gt[0 : n - 1] \leftarrow$ *Par-Prefix-Sum* ($gt[0 : n - 1]$, $+$)
10. $k \leftarrow q + lt[n - 1]$, $A[k] \leftarrow x$
11. *parallel for* $i \leftarrow 0$ *to* $n - 1$ *do*
12. *if* $B[i] < x$ *then* $A[q + lt[i] - 1] \leftarrow B[i]$
13. *else if* $B[i] > x$ *then* $A[k + gt[i]] \leftarrow B[i]$
14. *return* k

Work:

$$\begin{aligned} T_1(n) &= \Theta(n) && [\text{lines } 1 - 7] \\ &+ \Theta(n) && [\text{lines } 8 - 9] \\ &+ \Theta(n) && [\text{lines } 10 - 14] \\ &= \Theta(n) \end{aligned}$$

Span:

Assuming $\log n$ depth for *parallel for* loops:

$$\begin{aligned} T_\infty(n) &= \Theta(\log n) && [\text{lines } 1 - 7] \\ &+ \Theta(\log^2 n) && [\text{lines } 8 - 9] \\ &+ \Theta(\log n) && [\text{lines } 10 - 14] \\ &= \Theta(\log^2 n) \end{aligned}$$

Parallelism: $\frac{T_1(n)}{T_\infty(n)} = \Theta\left(\frac{n}{\log^2 n}\right)$

Parallel Quicksort

Randomized Parallel QuickSort

Input: An array $A[q : r]$ of distinct elements.

Output: Elements of $A[q : r]$ sorted in increasing order of value.

Par-Randomized-QuickSort ($A[q : r]$)

1. $n \leftarrow r - q + 1$
2. *if* $n \leq 30$ *then*
3. sort $A[q : r]$ using any sorting algorithm
4. *else*
5. select a random element x from $A[q : r]$
6. $k \leftarrow$ *Par-Partition* ($A[q : r], x$)
7. *spawn* *Par-Randomized-QuickSort* ($A[q : k - 1]$)
8. *Par-Randomized-QuickSort* ($A[k + 1 : r]$)
9. *sync*

Randomized Parallel QuickSort: Analysis

```
Par-Randomized-QuickSort (  $A[ q : r ]$  )  
1.  $n \leftarrow r - q + 1$   
2. if  $n \leq 30$  then  
3.   sort  $A[ q : r ]$  using any sorting algorithm  
4. else  
5.   select a random element  $x$  from  $A[ q : r ]$   
6.    $k \leftarrow \text{Par-Partition} ( A[ q : r ], x )$   
7.   spawn Par-Randomized-QuickSort (  $A[ q : k - 1 ]$  )  
8.   Par-Randomized-QuickSort (  $A[ k + 1 : r ]$  )  
9.   sync
```

Lines 1—6 take $\Theta(\log^2 n)$ parallel time and perform $\Theta(n)$ work.

Also the recursive spawns in lines 7—8 work on disjoint parts of $A[q : r]$. So the upper bounds on the parallel time and the total work in each level of recursion are $\Theta(\log^2 n)$ and $\Theta(n)$, respectively.

Hence, if D is the *recursion depth* of the algorithm, then

$$T_1(n) = O(nD) \text{ and } T_\infty(n) = O(D \log^2 n)$$

Randomized Parallel QuickSort: Analysis

```
Par-Randomized-QuickSort (  $A[ q : r ]$  )  
1.  $n \leftarrow r - q + 1$   
2. if  $n \leq 30$  then  
3.   sort  $A[ q : r ]$  using any sorting algorithm  
4. else  
5.   select a random element  $x$  from  $A[ q : r ]$   
6.    $k \leftarrow \text{Par-Partition} ( A[ q : r ], x )$   
7.   spawn Par-Randomized-QuickSort (  $A[ q : k - 1 ]$  )  
8.   Par-Randomized-QuickSort (  $A[ k + 1 : r ]$  )  
9.   sync
```

We already proved that w.h.p. recursion depth, $D = O(\log n)$.

Hence, with high probability,

$$T_1(n) = O(n \log n) \text{ and } T_\infty(n) = O(\log^3 n)$$